

CD RECEIVER

KDC-MP632U KDC-W6534U/UY KDC-X590 KDC-X7533U SERVICE MANUAL

KENWOOD

Kenwood Corporation

© 2006-3 PRINTED IN JAPAN
B53-0393-00 (N) 960

CD MECHANISM EXTENSION CORD (30P) : E39-0812-05

Panel assy
KDC-MP632U (A64-3760-01)

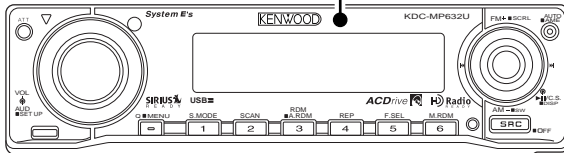

Panel assy
KDC-MP6534U/UY (A64-3762-01)

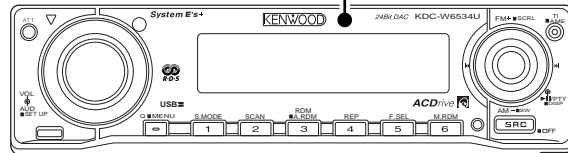

Panel assy
KDC-X590 (A64-3759-01)

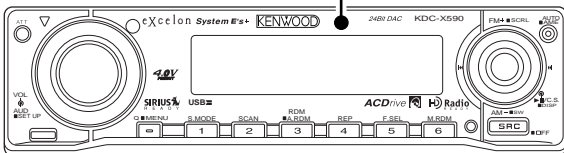

Panel assy
KDC-X7533U (A64-3761-01)

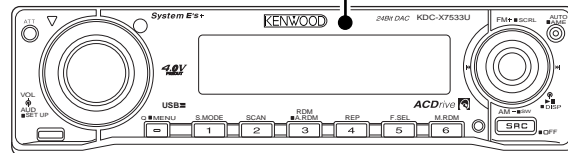

* Escutcheon
(B07-xxxx-xx)

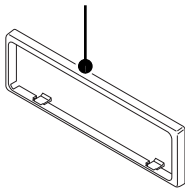

* Carrying case
(W01-xxxx-xx)

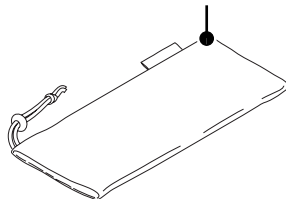

SPARE TDF PANEL

MAIN UNIT NAME	TDF PARTS No.	TDF NAME
KDC-MP632U	Y33-2540-61	TDF-MP66D
KDC-W6534U	Y33-2540-63	TDF-W6534U
KDC-W6534UY	Y33-2540-63	TDF-W6534U
KDC-X590	Y33-2540-60	TDF-65DX
KDC-X7533U	Y33-2540-62	TDF-X7533U

Mounting hardware assy
(J22-0011-03)

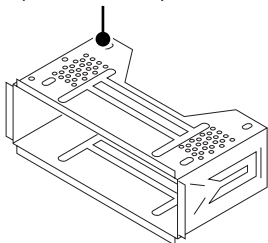

* DC cord
(E30-xxxx-xx)

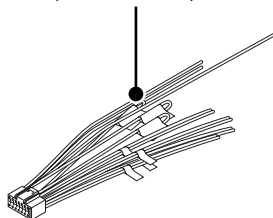

* DC cord
(E30-6412-05)

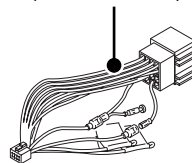

* Remote controller assy (RC-527)
(A70-2067-15)

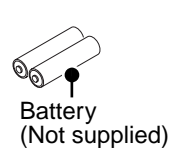
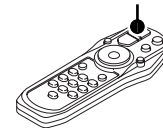

* Antenna adaptor
(T90-0523-05)



* Screw set
(N99-1757-05)

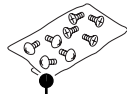

Screw set
(N99-1780-05)

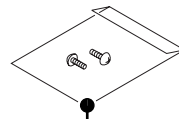

Lever
(D10-4589-04) x2

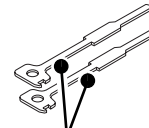

* Plastic cabinet assy
(A02-2743-03)

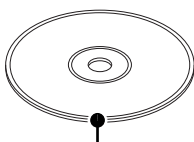
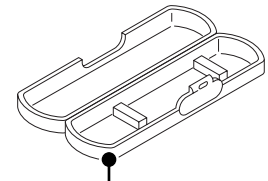

* Compact disc
(W01-xxxx-xx)



Mounting hardware (L)
(J22-0258-04)



Mounting hardware (R)
(J22-0259-04)

* Depends on the model. Refer to the parts list.

This product uses Lead Free solder.



BLOCK DIAGRAM

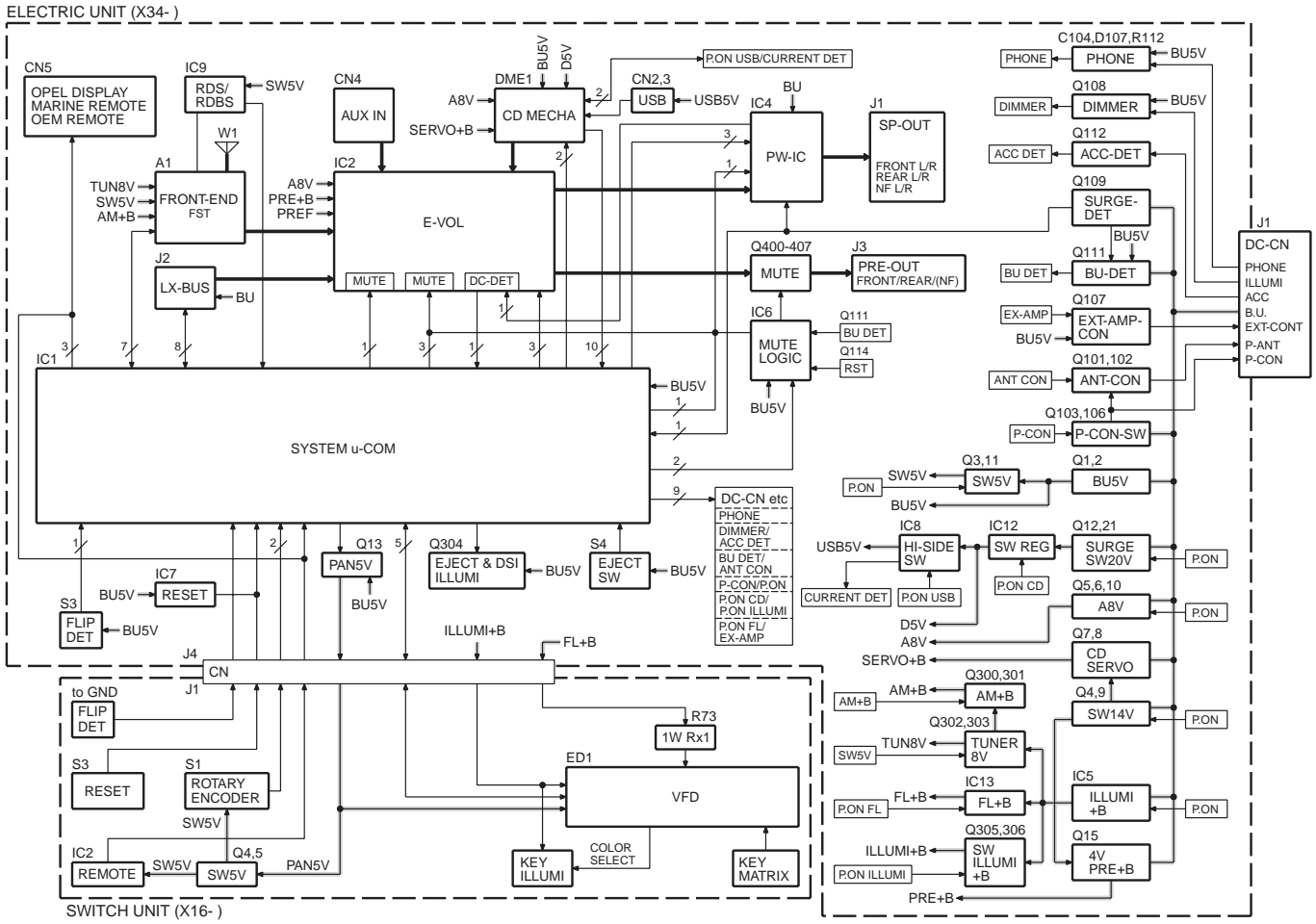

BLOCK DIAGRAM

CD PLAYER UNIT (X32-5830-00)

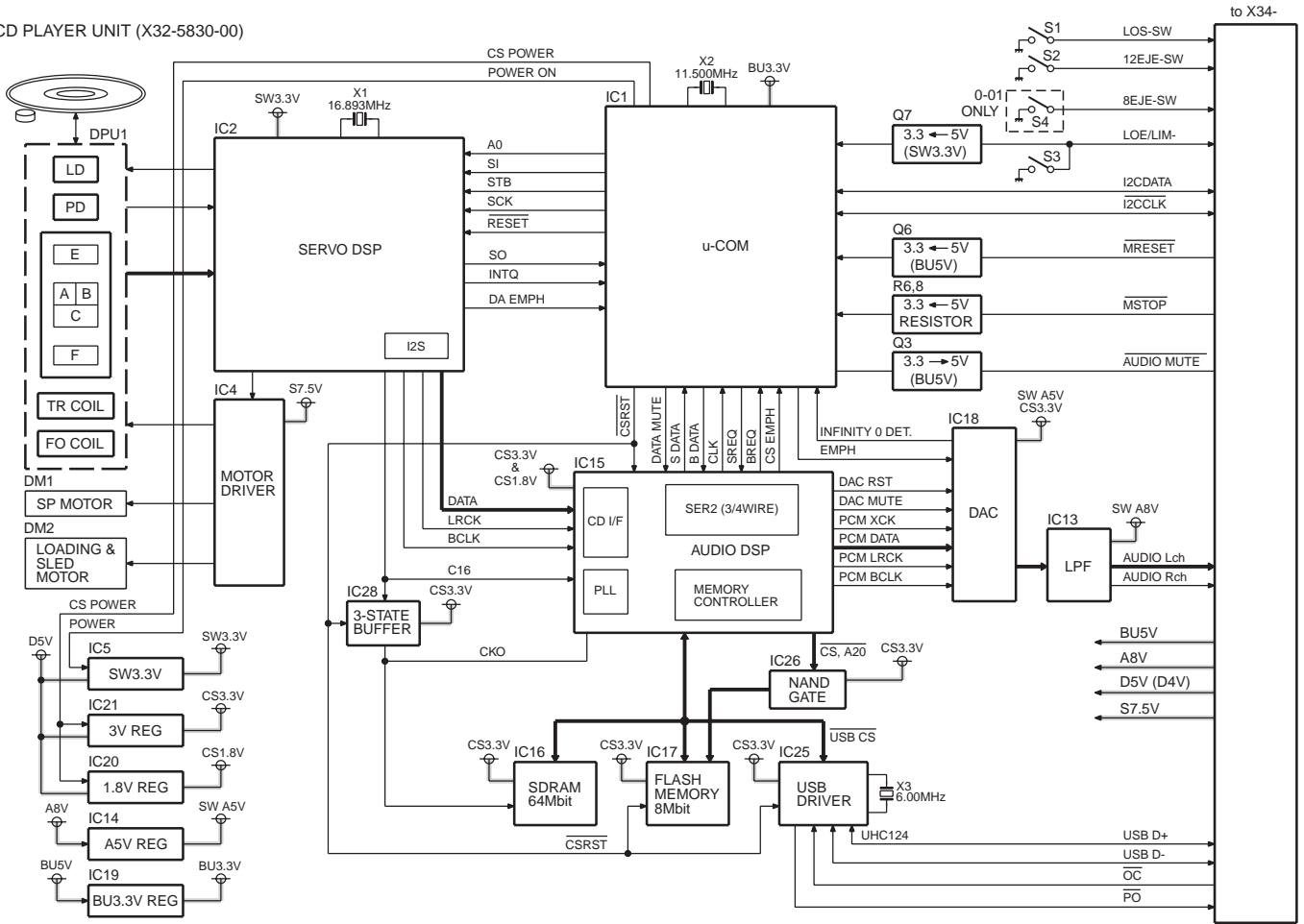

CD PLAYER UNIT (X32-)

ELECTRIC UNIT (X34-)

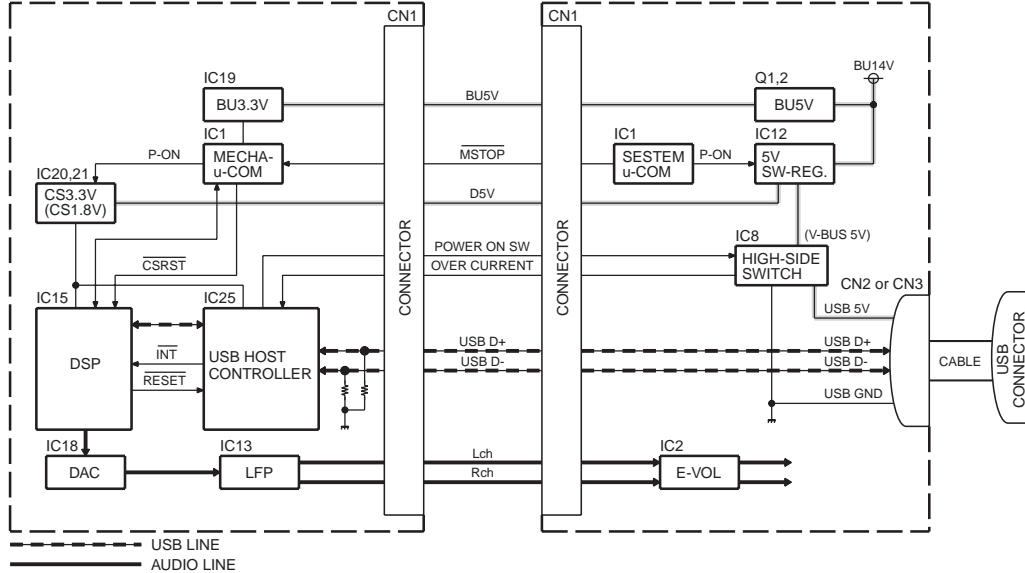

COMPONENTS DESCRIPTION

● ELECTRIC UNIT (X34-415x-xx)

Ref. No.	Application / Function	Operation / Condition / Compatibility
IC1	System μ -COM	Controls FM/AM tuner, the changer, CD mechanism, panel, volume and tone.
IC2	E-VOL	Controls the source, volume, tone.
IC3	A8V REF Power Supply	Outputs 1.27V.
IC4	Power IC	Amplifies the front L/R and the rear L/R to 50W maximum.
IC5	ILLUMI+B Power Supply	Outputs 11.25V.
IC6	Muting Logic IC	Controls logic for muting.
IC7	Reset IC	"Lo" when detection voltage goes below 3.6V or less.
IC8	Hi-side SW	Over current protection of USB power supply. When pin 1 goes "Hi", USB5V is ON.
IC9	RDS IC	Decodes RDS.
IC10	Installer Memory IC	Installer memory.
IC11	Analog IC	OP-AMP.
IC12	SW Regulator	Supplies power for USB and CD mechanism.
IC13	FL+B Power Supply	Outputs 3.0V.
Q1,2	B.U.5V AVR	While BU is applied, BU5V AVR outputs +5V.
Q3,11	SW5V	When Q11's base goes "Hi", SW5V outputs +5V.
Q4,9	SW14V	When Q9's base goes "Hi", SW14V outputs 14V.
Q5,6,10	AUDIO8V AVR	When Q10's base goes "Hi", A8V AVR outputs 8.0V.
Q7,8	SERVO+B AVR	When Q8's base goes "Hi", S+B AVR outputs 7.5V.
Q12,21	Serge Protect for IC12	Outputs 20V when BU is over 20V.
Q13	PANEL5V	When the base goes "Lo", PANEL5V outputs 5V.
Q14,16	4V-PRE+B Protect	When 4V-PRE+B is over current, Q14 and Q16 make Q15 turns off.
Q15	4V-PRE+B AVR	When the base is 8V, 4V-PRE+B outputs 7.4V.
Q17	IC12 ON/OFF	When the base goes "Lo", IC12 is "ON".
Q101,102	P-ANT SW	When Q102's base goes "Hi", P-ANT SW outputs 14V.
Q103,106	P-CON SW	When Q106's base goes "Hi", AVR outputs 14V.
Q104,105	P-CON Protection	Output protection is applied when P-CON output voltage fall is detected. The 2 transistors protect Q103 false operation when P-CON SW is "ON".
Q107	EXT-AMP-CON	When the base goes "Lo", Q107 is turned on.
Q108	Small Lamp DET SW	When the base goes "Hi", Q108 is turned on.
Q109	Serge DET	When the base goes "Hi", IC4 is changed into standby source.
Q111	BU DET	When the base goes "Hi", Q111 is turned on.
Q112	ACC DET	When the base goes "Hi", Q112 is turned on.
Q113	Mute Driver	When the base goes "Hi", pre-out mute driver is turned on.
Q116	Pre-out Mute Driver	When the base goes "Lo", mute driver is turned on.
Q300,301	AM+B	When Q301's base goes "Hi", AM+B is output.
Q302,303	Tuner8V	When Q303's base goes "Hi", Tuner8V outputs 8V.
Q304	DSI	When the base goes "Hi", security indicator lights.
Q305,306	SW ILLUMI+B	When Q306's base goes "Hi", SW ILLUMI+B outputs 11V.
Q400~407	Pre-out Mute SW	When the base goes "Hi", pre-out is muted.
Q408	Pre-out Mute ON/OFF	When the base goes "Lo", pre-out mute is "ON".

COMPONENTS DESCRIPTION

● SWITCH UNIT (X16-374x-xx)

Ref. No.	Application / Function	Operation / Condition / Compatibility
IC2	Remote Control IC	
Q4,5	SW5V	The power supply of IC2 is turned on when Q5's base level goes "Hi".
Q10	GREEN SW	When the base goes "Hi", LED lights.
Q12~14	Grid Driver	Each grid is ON when each transistor's base is "Lo".
Q15	RED SW	When the base goes "Hi", LED lights.
Q18	SUB ILLUMI SW	When the base goes "Hi", LED lights.
Q19	DBO ILLUMI SW	When the base goes "Hi", LED lights.
Q20	Key Scan Start SW	Key scan starts when the base goes "Hi".

● CD PLAYER UNIT (X32-5830-00)

Ref. No.	Application / Function	Operation / Condition / Compatibility
IC1	Mechanism μ -COM	
IC2	Signal Processor	
IC4	BTL Driver	Spindel motor, sled (including loading & eject) motor and pick-up actuator
IC5	SW3.3V Regulator	3.3V power supply for IC2, pick-up, IC18 digital part
IC13	Audio Active Filter	2nd LPF
IC14	A5V Regulator	3.3V power supply for DAC
IC15	DSP for Compression Audio Decoder	ACDrive decoder, MP3/WMA/AAC decoder
IC16	Compression Audio Codec SDRAM	
IC17	Decoder Software & Unique ID Strage Flash ROM	
IC18	Audio D-A Converter (24-bit external)	External 24-bit for audio
IC19	BU3.3V Regulator	3.3V power supply for μ -com
IC20	1.8V Regulator	1.8V power supply for IC15 core part
IC21	Decoder/SDRAM/Flash ROM/USB Driver 3.3V Regulator	Power supply for decoder, SDRAM, flash ROM and USB driver. 3.3V power supply for IC15 port parts, IC16, IC17, IC25, IC26 and IC28.
IC25	USB Host Controller	
IC26	Switching among IC15 & Flash ROM & SDRAM & USB	For DSP for Compression Audio Decoder, Flash ROM, SDRAM and USB
IC28	Clock SW	To SDRAM
Q3	Level Shift 3.3V \rightarrow 5V	
Q6,7	Level Shift 3.3V \leftarrow 5V	
Q8	APC (Auto Power Control)	
Q9,10	Anticipation Sub-beam Delay	During non-searching
Q17	USB Hi-side SW	
D2	Static Electricity Countermeasure	For IC2 built-in reset terminal
D3	Laser Diode Protection	
D9	Static Electricity Countermeasure	

MICROCOMPUTER'S TERMINAL DESCRIPTION

● SYSTEM μ -COM: IC1 on X34- (ELECTRIC UNIT)

Pin No.	Pin Name	I/O	Application	Truth Value Table	Processing / Operation / Description
1	REMO	I	Remote control signal input		Detects pulse width
2	LX MUTE	I	Mute request from slave unit		H: Mute ON, L: Mute OFF
3	AUD SDA	O	E-VOL data output		
4	AUD SEL	O	E-VOL control		
5	AUD SCL	O	E-VOL clock output		
6	BYTE	-			
7	CNVSS	-			
8	XCIN	I			
9	XCOUT	I			
10	RESET	-			
11	XOUT	-			
12	VSS	-			
13	XIN	-	12.0MHz		
14	VCC1	-			
15	NMI	-	Not used		
16	$\overline{\text{CN DET}}$	I	Panel communication detection (Flip-down panel model only)		H: Panel detached, L: Panel attached
17	RDS CLK	I	RDS decoder clock input		
18	LX REQ S	I	Communication request from slave unit		
19	PON AM	I/O	AM power supply control		H: Receiving AM, Hi-z: No AM
20	LX REQ M	O	Communication request to slave unit		
21	TUN IFC OUT	I	Front-end IFC-OUT input		H: Station found, L: No station
22	NC	-	Not used		L fixed
23	RDS AFS M	I/O	Noise detection time constant switching	①	Refer to the truth value table
24	RDS QUAL	I	RDS decoder QUAL input		
25	RDS DATA	I	RDS decoder data input		
26	PWIC BEEP	O	Beep output		
27	TUN SCL	I/O	Front-end I2C clock input and output		MAX400kHz
28	TUN SDA	I/O	Front-end I2C data input and output		
29	VFD DATA	I/O	VFD data input and output		
30	VFD INT	I	VFD INT input		INT input
31	VFD CLK	O	VFD clock output		Normal: 125kHz, Low consumption mode: 62.5kHz
32	VFD RST	O	VFD driver reset		H: Canceling reset, L: Reset L: Momentary power down, panel detached or 11 minutes after ACC OFF
33	ROMCOR SDA	I/O	E2PROM I2C data input and output for ROM correction		
34	ROMCOR SCL	I/O	E2PROM I2C clock output for ROM correction		
35	$\overline{\text{PON PANEL}}$	I/O	Panel 5V control (Flip-down panel model only)		L: ON Hi-Z: Momentary power down, panel detached or 11 minutes after ACC OFF
36	DSI	I/O	DSI/EJECT LED control (Flip-down panel model only)		OFF: Hi-z, Pulse drive: Panel detached H: Illumination ON or panel opened (POWER ON)
37,38	NC	-	Not used		L fixed

MICROCOMPUTER'S TERMINAL DESCRIPTION

Pin No.	Pin Name	I/O	Application	Truth Value Table	Processing / Operation / Description
39	EPM	I	Flash EPM input		
40	PANEL DET	I	Panel detection (Flip-down panel model only)		L: Panel detached, H: Panel attached
41	NC	-	Not used		L fixed
42	ROMCOR DET	I	E2PROM writing request		H: Writing
43	PON FL	O	FL+B control		H: FL+B ON, L: FL+B OFF
44	VFD CS	O	VFD chip select control		
45	ROTARY CW	I	VOL key input		Detects pulse width
46	ROTARY CCW	I	VOL key input		Detects pulse width
47	CD DISC12 SW	I	12cm CD detection		
48	CD LOS SW	I	CD loading detection		
49	CD MUTE R	I	Rch CD mute request		H: Normal, L: Requesting Rch mute
50	CD MUTE L	I	Lch CD mute request		H: Normal, L: Requesting Rch mute
51	CD MRST	O	CD mecha μ -COM reset		H: Normal, L: Reset
52	CD MSTOP	O	CD mechanism μ -COM stop		H: Mecha μ -COM operates, L: Mecha μ -COM stops
53	CD DISC8 SW	I	8cm CD detection (Not used)		
54	CD LOE LIM SW	I	CD detection (Chucking SW)		H: Loading completes, L: No disc
55	CD LOEJ	I/O	CD motor control	②	Refer to the truth value table
56	CD MOTOR	O	CD motor control	②	Refer to the truth value table
57	PON ILLUMI	I/O	Key illumination power supply control		H: ON, Hi-Z: OFF
58	PON CD	O	Power supply control for CD-WMA		L: POWER ON, H: POWER OFF L: Before M-STOP with reset
59	PON	O	Power supply		H: POWER ON, L: POWER OFF
60	VCC2	-			
61	EXT AMP CON	I/O	EXTERNAL AMP control		
62	VSS	-			
63-65	TYPE 1~3	I	Destination switching	③	Refer to the truth value table
66	TUN TYPE1	I	Destination setting 1	④	Refer to the truth value table
67	TUN TYPE2	I	Destination setting 2	④	Refer to the truth value table
68	OEM DISP DATA	I/O	External display data (Destination K and E only)		External display
69	OEM DISP CLK	I/O	External display clock (Destination K and E only)		External display
70	OEM DISP CE	I/O	External display control request (Destination K and E only)		External display
71	EJECT	I	Eject key input (Flip-down panel model only)		L: Eject
72	P CON	O	External amplifier control		H: POWER ON, L: POWER OFF or STANDBY
73	VFD KEY REQ	I	Communication request from VFD driver		Connects to INT
74	ANT CON	O	Power antenna control		Tuner ON: H
75	ILLUMI DET	I	Dimmer illumination detection		L: ON, H: OFF
76	BU DET	I	Momentary power-down detection		L: BU found, H: No BU or momentary power down
77	ACC DET	I	ACC power supply detection		L: ACC found, H: No ACC
78	(PWIC SVR)	O	SVR discharging circuit		H: POWER OFF or 5 seconds after momentary power down, L: Other conditions
79	PWIC MUTE	O	Power IC mute		L: STANDBY, momentary power down or TEL mute
80	PWIC STBY	O	Power IC standby control		H: POWER ON, L: POWER OFF
81	LX CON	O	Start-up request to slave unit		H: Slave unit starts up, L: Slave unit stops

MICROCOMPUTER'S TERMINAL DESCRIPTION

Pin No.	Pin Name	I/O	Application	Truth Value Table	Processing / Operation / Description
82	MUTE PRE R	O	Rch preout mute		CD MUTE R is Lo: H (CD playing), Momentary power down: H, L: DUAL ZONE or NAVI INT
83	MUTE PRE L	O	Lch preout mute		CD MUTE L is Lo: H (CD playing), Momentary power down: H, L: DUAL ZONE or NAVI INT
84	$\overline{\text{MUTE 0}}$	I/O	E-VOL front mute		L: Mute ON, Hi-Z: Mute OFF
85	$\overline{\text{MUTE 1}}$	I/O	E-VOL rear mute		L: Mute ON, Hi-Z: Mute OFF
86	$\overline{\text{MUTE 2}}$	I/O	E-VOL mute (Except front/rear)		
87	LINE MUTE	I	Line mute detection		TEL mute: Below 1V NAVI mute: Over 2.5V
88	$\overline{\text{MUTE PRE SW}}$	I/O	NF preout mute		L: Mute ON, Hi-Z: Mute OFF OFF fixed: Selecting REAR in REAR/SUB selection
89	PWIC DC DET	I	DC offset error detection		
90	LX RST	O	Forced reset to slave unit		H: Reset, L: Normal
91	$\overline{\text{MUTE C}}$	I/O	E-VOL mute		L: Mute ON, Hi-Z: Mute OFF
92	NC	-	Not used		L fixed
93	RDS NOISE	I	FM noise detection		
94	AVSS	-			
95	TUN SMETER	I	S-meter input		
96	VREF	-			Connects to P.ON
97	AVCC	-			Connects to VCC
98	LX DATA S	I	Data from slave unit		
99	LX DATA M	I/O	Data from and to slave unit		
100	LX CLK	I/O	LX-BUS clock		

Truth value table

① AFS CONTROL

	RDS AFS M	Condition
AFS LOW	L	No sound output with AF search
AFS MID	L	Sound output with AF search
AFS HIGH	Hi-Z	Normal reception

② CD MOTOR CONTROL

	CD MOTOR	CD LOADING/EJECT
Stop	L	L
Load	H	L
Eject	H	H
Brake	H	Hi-z

③ DESTINATION SW

TYPE 3 (Pin 65)	TYPE 2 (Pin 64)	TYPE 1 (Pin 63)	DESTINATION	MODEL
0	0	0	K	KDC-X590
0	0	1	K	KDC-MP632U
0	1	0	E	KDC-W6534U/UY
0	1	1	E	DPX501U/UY
1	0	0	M	KDC-X7533U
1	0	1	M	DPX-MP2090U
1	1	0	K	DPX501
1	1	1	J	DPX-U077

④ TUNER TYPE

	TUN TYPE1 (Pin 66)	TUN TYPE2 (Pin 67)
Kenwood brand model	L	L
OEM model 1	L	H
OEM model 2	H	L
OEM model 3	H	H

MICROCOMPUTER'S TERMINAL DESCRIPTION

● MECHANISM μ -COM: IC1 (X32:- CD PLAYER UNIT)

Pin No.	Pin Name	I/O	Application	Processing / Operation / Description
1~5	NC	-	Not used	Opened output L fixed
6	BYTE	I	External data bus SW input	Connects to GND
7	CNVSS	I	Processor mode SW	L: Single chip mode H: Microprocessor mode or flash ROM writing
8	$\overline{\text{MUTE}}$	O	Audio mute control	L: Mute ON, H: Mute OFF
9	NC	-	Not used	Opened output L fixed
10	$\overline{\text{RESET}}$	I	Reset detection	L: Reset (Flash ROM writing), H: Normal
11	XOUT	O	Main clock output	Connects to resonator
12	VSS	-	Power supply input	Connects to GND
13	XIN	I	Main clock input	Connects to resonator
14	VCC1	-	Power supply input	Connects to BU3.3V
15	$\overline{\text{NMI}}$	I	NMI interruption input	Input Hi (Pull-up) fixed
16	$\overline{\text{MSTOP}}$	I	STANDBY comeback interruption	L: Stop, H: Stop cancelled (Hi edge)
17	NC	-	Not used	Opened output L fixed
18	DSP INT	I	DSP interruption signal input	H: Interruption (Hi edge)
19~22	NC	-	Not used	Opened output L fixed
23	E2P SCL	I/O	E2P I2C clock output	Series resistors and E2PROM are not built when ROM collection is not used.
24	E2P SDA	I/O	E2P I2C data input and output	Series resistors and E2PROM are not built when ROM collection is not used.
25,26	NC	-	Not used	Opened output L fixed
27	SCL	I	System μ -com I2C clock input	
28	SDA	I/O	System μ -com I2C data input and output	
29	DSP TXD	O	Data output for DSP serial data	Flash ROM writing: TXD (Pull-up)
30	DSP RXD	I	Data input for DSP serial data	Flash ROM writing: RXD
31	DSP CLK	O	Clock output for DSP serial data	Flash ROM writing: SCLK(Pull-up)
32	DSP STB(BUSY)	O	DSP data strove signal output	Flash ROM writing: BUSY
33	CS SDATA	O	Data output for decoder serial data	
34	CS BDATA	I	Data input for decoder serial data	
35	CS CLK	O	Clock output for decoder serial data	
36~38	NC	-	Not used	Opened output L fixed
39	$\overline{\text{EPM}}$	-	Not used (Flash ROM: EPM)	Opened output L fixed
40	PON D3.3	O	D3.3V POWER ON control	H: POWER ON, L: POWER OFF
41	PON A5	O	A5.0V POWER ON control	H: POWER ON, L: POWER OFF
42	PON CS1	O	IC15 series 3.3V POWER ON control	H: POWER ON, L: POWER OFF
43	PON CS2	O	IC15 series 1.8V POWER ON control	H: POWER ON, L: POWER OFF
44	CE	-	Not used (Flash ROM: CE)	Opened output L fixed
45	$\overline{\text{DRV MUTE}}$	O	Driver mute	L: Stop, H: Mute OFF
46,47	NC	-	Not used	Opened output L fixed
48	ZERO M	I	0-bit mute detection	H: Mute ON, L: Mute OFF (No distinction of Lch/Rch)
49	DE-EMPHASIS	O	DAC de-emphasis control	H: De-emphasis ON, L: De-emphasis OFF
50,51	NC	-	Not used	Opened output L fixed
52	LIM SW	I	Laser pick-up inner circumference detection SW signal input	H: Inner circumference

MICROCOMPUTER'S TERMINAL DESCRIPTION

Pin No.	Pin Name	I/O	Application	Processing / Operation / Description
53	DISC NORMAL	O	Media discrimination result output (Not used)	H: Normal disc, L: Other disc
54	DISC H RW	O	Media discrimination result output (Not used)	H: High reflecting RW disc, L: Other disc
55	DISC RW	O	Media discrimination result output (Not used)	H: Normal RW disc, L: Other disc
56~59	TEST OUT4~1	O	Output for test	Opened output L fixed
60	VCC2	-	Power supply input	Connects to BU3.3V
61	TEST OUT0	O	Output for test	Opened output L fixed
62	VSS	-	Power supply input	Connects to GND
63~66	NC	-	Not used	Opened output L fixed
67	TEST IN3	I	TEST IN3	Pull-down connection (L: Normal/H: During test)
68	MODEL SEL	I	Model determination	L: DXM-6810W (X32-583), H: DXM-6820W (X32-587)
69	E2P WRITE	I	TEST IN1: E2P writing permission	Pull-down connection (L: Normal/H: During writing)
70	UNIQ ID	I	TEST IN0: Unique ID writing permission	Pull-down connection (L: Normal/H: During writing)
71~73	NC	-	Not used	Opened output L fixed
74	SEARCH	O	Searching situation output	H: During seaching, L: Normal
75,76	NC	-	Not used	Opened output L fixed
77	DSP RST	O	DSP reset control	L: Reset, H: Normal
78	DSP A0	O	DSP command/parameter discrimination signal output	H: During parameter transmitting L: During command transmitting
79	DA EMPHASIS	I	DSP DA emphasis input	H: emphasis ON, L: emphasis OFF
80	ROM EMPHASIS	I	Decoder ROM emphasis input	H: emphasis ON, L: emphasis OFF
81	DATA MUTE	O	Data output status	L: During data output muting, H: During data output
82	CS RST	O	Decoder reset control	L: Reset, H: Normal
83	NC	-	Not used	Opened output L fixed
84	SREQ	O	Decoder SREQ signal output	
85	BREQ	I	Decoder BREQ signal input	
86~93	NC	-	Not used	Opened output L fixed
94	AVSS	-	Analog power supply input	Connects to GND
95	NC	-	Not used	Opened output L fixed
96	VREF	-	Reference voltage input	Not used: Connects to GND
97	AVCC	-	Analog power supply input	Connects to BU3.3V
98~100	NC	-	Not used	Opened output L fixed

TEST MODE

● How to enter the test mode

Press and hold the [1] and [3] keys and reset.
(While “- - - -” is being displayed, power can be ON for 30 minutes.)

● How to clear the test mode

Reset, momentary power down, Acc OFF, Power OFF, detach the panel.

● Initial conditions of the test mode

- Source is STANDBY.
- Displays lights are all turned on.
- The volume is at -10dB (The display is 30).
- Loudness (LOUD) is OFF.
- CRSC is OFF, regardless of whether there are switching functions or not.
- SYSTEM Q is NATURAL (=FLAT).
- BEEP will sound anytime with a less than 1 second push.
- Auxiliary (AUX) is ON.
- SWPRE is SUB WOOFER.

● RDS automatic measurement

Conventionally, the PS display has been visually checked on the production line. This will be replaced by a new processing. The PS data will be received and the PS contents is to be verified as “RDS_TEST”. When this is verified, the P-CON terminal is forced to go OFF. (In this case, “_” means blank.)

→ This will be a dedicated test mode processing.

On the P-CON, when power is turned off once and, then, turned on again, (Power OFF → ON) the unit will be re-started.

● Special display when set to TUNER

When in TUNER mode, if any of the following displays appear, there is an abnormality with the front-end.

- “TNE2P_NG” : The E2PROM of front-end is still with the default (unspecified) value.
- “TNCON_NG” : The communication with the front-end is not possible.

● Forced switching of K3I

In TUNER FM mode, each time [6] key is pressed, the functions move in the following cycle :

AUTO → forced WIDE → forced MIDDLE → force NARROW → AUTO

The initial condition is AUTO and the displays below will appear.

- AUTO : FM1_98.1A
- Forced MIDDLE : FM1_98.1M

- Forced WIDE : FM1_98.1W
- Forced NARROW : FM1_98.1N

● CD receiver test mode specifications

- Display mode default setting shall be P-TIME.
- Jumps are made to the following tracks by pressing the [▶▶1] key.
No. 9 → No. 15 → No. 10 → No. 11 → No. 12 → No. 13 → No. 22 → No. 14 → No. 9 (Returns to the beginning)
It must be noted, however, that when paying MP3 / WMA / AAC disc, which contain 8 files or less, the first track and the following tracks are played in order.
- Pressing the [◀◀1] key goes back by 1 track from the track being played.
- When playing an MP3 / WMA / AAC disc, display the file format before starting to play each file. (“MP3”, “WMA”, “AAC”)
- When in CD source, by pressing [1] key for less than 1 second, a jump to the Track No. 28 is made.
- When in CD source, by pressing [2] key for less than 1 second, a jump to the Track No. 14 is made.
- While in CD source, press the [3] key to display the CD mechanism model name and the version. Press the [3] key again to go back to the normal screen. (Time code display)

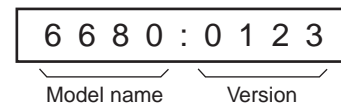

- When CD is the source, press the [6] key to jump to No. 15. At this time, the volume value is set to 25 (2V PRE) or 27 (4V PRE).

● USB source test mode specification

- While in USB source, press the [6] key to set volume value to 15.

● Audio adjust mode

Model with no DSP

- By pressing [AUD] key for less than 1 second, the audio adjustment mode can be entered.
- Using the remote controller [*] key and [AUD] key, the audio adjustment mode can be entered.
- Adjustment items of both the AUDIO FUNCTION MODE and SETUP MODE are included.
- The initial item will be Fader, which is followed by : Balance → Bass Level → Middle Level → Treble Level → HPF Front → HPF Rear → LPF Sub Woofer (After this, it will be arbitrary)

TEST MODE

- With the remote controller, continuous forwarding is prohibited.
- Using the VOL knob, [◀◀] and [▶▶] key, the Fader can be adjusted in 3 steps : R15 ↔ 0 ↔ F15 (The initial value is 0)
- Using the VOL knob, [◀◀] and [▶▶] key, the Balance can be adjusted in 3 steps : L15 ↔ 0 ↔ R15 (The initial value is 0)
- Using the VOL knob, [◀◀] and [▶▶] key, the Bass / Middle / Treble Level can be adjusted in 3 steps : -8 ↔ 0 ↔ +8 (The initial value is 0)
- Using the VOL knob, [◀◀] and [▶▶] key, the HPF Front / Rear can be adjusted in 2 steps : Through ↔ 180Hz (or 220Hz) (The initial value is Through)
- Using the VOL knob, [◀◀] and [▶▶] key, the LPF Sub Woofer can be adjusted in 2 steps : 60Hz (or 50Hz) ↔ Through (The initial value is Through)
- Using the VOL knob, [◀◀] and [▶▶] key, the Sub Woofer Phase can be adjusted in 2 steps : Reverse ↔ Normal (The initial value is Normal)
- Using the VOL knob, [◀◀] and [▶▶] key, the Volume Offset can be adjusted in 2 steps : -8 ↔ 0 (The initial value is 0)
- Using the VOL knob, [◀◀] and [▶▶] key, the Loudness ON/OFF can be adjusted in 2 steps : OFF ↔ ON (The initial value is OFF)
- Using the VOL knob, [◀◀] and [▶▶] key, 2-Zone ON/OFF can be adjusted in 2 steps : OFF ↔ ON (The initial value is OFF)
- Bass f / Bass Q / Bass EXT / Middle f / Middle Q / Treble f do no appear in audio adjustments.

● MENU

- Press the [Q] key to enter the MENU.
- Press the remote control [DNPP/SBF] key or the [DIRECT] key to enter the MENU.
- Continuous forwarding by remote control is prohibited.
- Initial item in CD/USB source is "F/W Version".

● 2-ZONE (Dual Zone) items (Model with 2-ZONE only)

- When using sources other than the STANDBY source, press [AUTO] or [TI] key for less than 1 second, 2-ZONE ON/OFF is achieved.

● Backup current measurement

When reset in ACC OFF (Back Up ON) condition, MUTE terminal goes off after 2 seconds, instead of 15 seconds. (During this time, the CD mechanism does not function.)

● OPEL communication items (Model with OPEL communication)

During the test mode, OPEL communication line outputs the following (At every 500msec, the output condition of the communication line will be switched.)

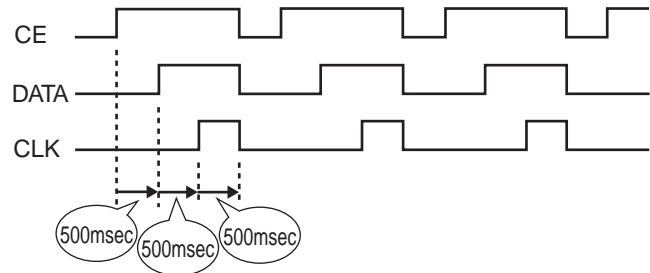

● Special displays while all lights are on

When all lights are on with STANDBY source, if the following keys are pressed, the following messages are displayed.

[1] key	Version is displayed (forwarding) (Display) TYPE : x_ _ _ ("x" is displayed in hexadecimal) → 512K - 1.02 ("development ID" - "version") → all lights on → * TYPE indicates μ-com destination, and shows real-time condition of the destination terminal.
[2] key	Serial No. is displayed (8 digits) (Display) xxxxxxxx
[3] key	Key pressed: Power ON time is displayed. While Power ON time is displayed, press and hold for 2 seconds or longer to clear the Power ON time. (Display) PON_0Hxx (00~50 is displayed for "xx". When less than 1 hour, display by increment of 10 minutes.) xxxxx (00001~10922 is displayed for "xxxxx") MAX 10922 (hours)
[4] key	Key pressed: CD operation time is displayed. Press the key for more than 2 seconds while the CD operation time is displayed to clear CD operation time. (Display) CDT_0Hxx (00~50 is displayed for "xx". When less than 1 hour, display by increment of 10 minutes.) xxxxx (00001~10922 is displayed for "xxxxx") MAX 10922 (hours)

TEST MODE

● Other

- At Power ON, "CODE_OFF", "CODE_ON" displays will not be made.
- During STANDBY sourcing, by pressing [AUTO] or [TI] key, for less than 1 second GREEN/RED of the key illumination is switched. (Model with illumination switched function only)
With KDC-X590 / KDC-X7533U models, which are installed with Display Blackout function, switching will be made in the following order :

KDC-X590	Key illumi		Triangle illumi	
	GREEN	RED	GREEN	RED
①	OFF	ON	OFF	ON
②	OFF	OFF	ON	OFF
③	OFF	ON	OFF	ON
④	OFF	OFF	ON	OFF

KDC-X7533U	Key illumi		Triangle illumi	
	GREEN	RED	GREEN	RED
①	ON	OFF	OFF	ON
②	OFF	OFF	ON	OFF
③	OFF	ON	OFF	ON
④	OFF	OFF	ON	OFF

* With the hardware configuration, when either GREEN/RED of the key illumination could lights up, the RED of the triangle illumination is to be lighted.

When desiring to light up GREEN of the triangle illumination, turn off both GREEN and RED of the key illumination.

- During STANDBY sourcing, by pressing [AUTO] or [TI] key for at least 1 second, Rear/Sub Woofer of PREOUT is switched. (Model with 2-PREOUT)
- When starting up in the test mode, LINE MUTE prohibition time is set to 1 second instead of 10 seconds.
- While in the test mode, even when a DC offset error is detected, the detection information will not be written to the E2PROM.
- While in the test mode, even after an elapse of pre-set time, the backup memory items will not be written to the E2PROM.
- Information Clear mode for Test Mode, backup/installer memory, and CD mechanism error log, in the DC offset error detection information clear mode, DEMO mode operation will not be conducted.

Also, in the above mode, the menu of the STANDBY source will not display DEMO ON/OFF switching items.

● Clearing backup/installer memory, CD mechanism information and service information (E2PROM data clearing)

1. While pressing the [Q] key and [ATT] key, reset-start to start backup/installer memory data, CD mechanism and service information initialization.

(While "----" is being displayed, power can be ON for 30 minutes.)

[CD mechanism information]

- Displays I2C communication condition
- Displays CD mechanism error log
- Displays CD loading error data.
- Displays CD ejection error data
- Displays CD time code error count data (missing count)
- Displays CD time code error count data (count not updated)

[Service information]

- Displays power ON time is displayed
- Displays CD operation time
- Displays number of CD EJECT times
- Displays number of times panel was opened/closed
- Displays forced Power OFF data

2. When initialization is complete, the following display will be made.

Normal completion

```
CD _ O : A U _ O _
```

Abnormal ending 1 : backup/installer memory initialization : NG

```
CD _ O : A U _ X _
```

Abnormal ending 2 : CD mechanism error log initialization : NG

```
CD _ X : A U _ O _
```

Abnormal ending 3 : All initialization : NG

```
CD _ X : A U _ X
```

TEST MODE

3. While in this mode, even after an elapse of a pre-set time, no backup memory items will be written to the E2PROM.
4. This mode is released by resetting. (What was on the last screen will not be retained.)

● Clearing DC offset error detection data (E2PROM data clearing)

If DC voltage difference (DC offset error) is detected between audio power amplifier (power IC) \pm outputs, "DC_ERR_" is displayed on the display. When this occurs, the audio is forced-mute and the display displays only "DC_ERR_".

Once this product detected a DC offset error, even if it is restarted (or reset), its display displays "DC_ERR_".

However, if the error is detected while in Test Mode, it is not saved in E2PROM.

1. Press and hold [3] and [6] keys and reset-start to go into the DC offset error display mode.
(While "----" is being displayed, power can be ON for 30 minutes.)
2. While in STANDBY source, the current DC offset error condition is displayed.
When detected : "DC_ERR_"
When not detected: "DC_OK_"
3. While error condition is being displayed, press [AUTO] or [TI] key to clear the detection data. (Clear E2PROM)
4. DC offset error display mode is cancelled by resetting. (The last screen will not be retained.)

● FM/AM channel space switching (KDC-MP632U/X590/X7533U)

From the Power OFF condition, while pressing [1] and [5] keys down simultaneously, press the [SRC] key and turn power ON.

● Security

• Forced Power ON mode

While "----" is being displayed, by resetting while pressing [Q] key and [4] key simultaneously, it is possible to turn the power ON for 30 minutes only.

• How to register the security code on the "Car Audio Passport" after replacement of the E2PROM (IC10) (KDC-W6534U/W6534UY/X7533U)

1. Enter the test mode. (Refer to the section on "How to Enter the Test Mode.")

2. Enter the MENU by pressing [Q] key for less than 1 second.
While "CODE_SET" is being displayed, press [▶▶] key for at least 1 second and enter the security registration mode.
3. Using [FM] / [AM] / [◀◀] / [▶▶] keys, enter the code.
[FM] key : Number up / [AM] key : Number down
[▶▶] key : Cursor Right / [◀◀] key : Cursor Left
4. Press [▶▶] key for at least 3 seconds to display "RE-ENTER". Then, re-enter the code using the method in above No. "3".
5. Press [▶▶] key for at least 3 seconds to display "APPROVED".
6. Release the test mode. (Refer to the section on "How to Release the Test Mode.")

Note : The security code for this model cannot be deleted by "all clear" command.

● Method of clearing the programmable security code (KDC-MP632U/X590)

1. While "----" is being displayed, press [▶▶] key for at least 3 seconds while pressing [AUTO] or [TI] key.
This makes "----" display disappear.
2. Using the remote controller, input "KCAR".
Press remote controller [5] key 2 times (Input for "K") and then press [▶▶] key.
Press remote controller [2] key 3 times (Input for "C") and then press [▶▶] key.
Press remote controller [2] key once (Input for "A") and then press [▶▶] key.
Press remote controller [7] key 2 times (Input for "R") and then press [▶▶] key.
3. The security is released and the unit enters the STANDBY mode.
4. If a wrong code is input, the unit goes into the Code Request mode.

INSTALLER MEMORY SPECIFICATIONS

At specialists (or specialty stores), when the installer sends the vehicle back to the user, they may make the store-recommended audio configuration.

When the user changes the setting values, when the backup power supply was taken out at times of battery change or when the reset button was pressed, to make it possible to recall the setting values, the store-recommended configuration values can be saved into E2PROM.

The specification detail defer in "with-DSP model" and in "without-DSP model".

[Models without DSP]

- Calling and saving the configuration is done by the MENU.
- Items to be saved are Bass, Middle, Treble, X' over, and Sub Woofer Level. Only one setting can be saved for each item (Bass/Middle/Treble settings can be changed for each source, but only one setting can be saved as the installer

memory specification, and the source in which the saving operation was carried out is saved as such).

- The contents read out by the call key shall be reflected only to the current source at the time → EQ curve is "USER" (Bass/Middle/Treble settings can be changed for each source, but not reflected to Bass/Middle/Treble settings of sources other than where the calling operation was carried out).
- When the backup power supply was taken out at times of battery change or when the reset button was pressed, as the initial setting values of Bass, Middle, Treble, X' over, and Sub Woofer Level, the saved memory is reflected. (Bass/Middle/Treble setting initial setting value memory is reflected in all sources.)

[NOTE] By such, EQ curve initial setting shall always be "USER" (NOT "NATURAL" or "FLAT").

BACKUP MEMORY SPECIFICATIONS

Settings by the user other than the installer memory items are saved into the E2PROM, and when the backup power supply was taken out at times of battery change or when the reset button was pressed, it is made possible to recall the setting values saved.

- While Power ON, the memory is saved and accumulated at a certain interval (temporary).
- Items to be saved into the memory are: Volume Offset (for all sources) and preset frequencies (FM/AM all bands x 6 channels).

- When the backup power supply was taken out at times of battery change or when the reset button was pressed, as the initial setting values of Volume Offset (for all sources) and preset frequencies (FM/AM all bands x 6 channels), the saved memory is reflected.
- In models which includes channel space switching, when channel space is switched, TUNER-preset frequencies are set back to the default values.

PC BOARD (COMPONENT SIDE VIEW)

SWITCH UNIT X16-374x-xx
(J76-0239-02)

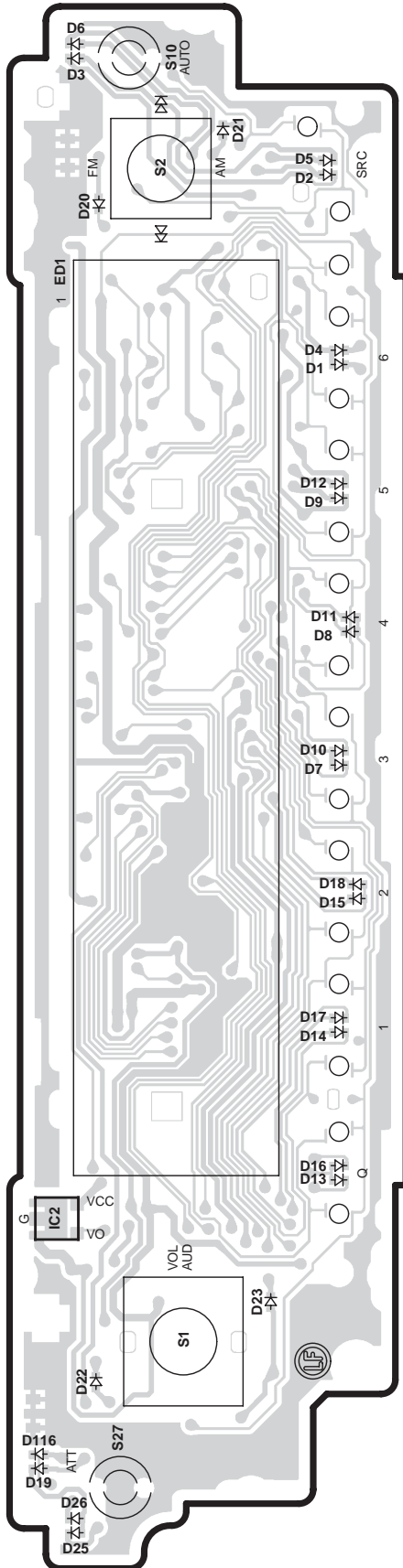

X16-374x-xx

Ref. No.	Address
IC2	6A

(FOIL SIDE VIEW)

SWITCH UNIT X16-374x-xx
(J76-0239-02)

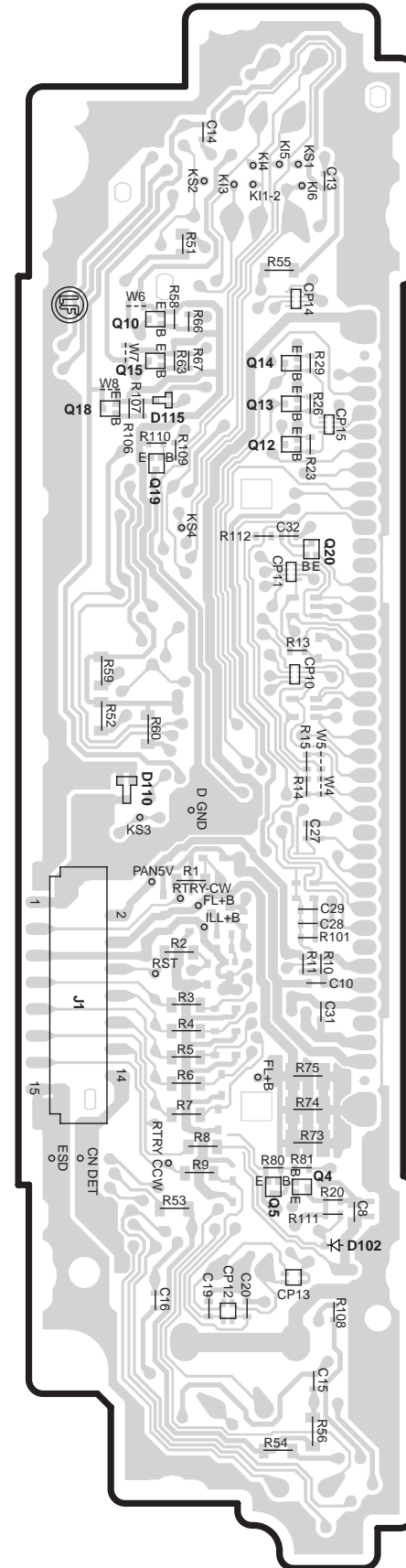

X16-374x-xx

Ref. No.	Address
Q4	6D
Q5	6D
Q10	3C
Q12	3D
Q13	3D
Q14	3D
Q15	3C
Q18	3C
Q19	3C
Q20	3D

Refer to the schematic diagram for the values of resistors and capacitors.

PC BOARD (COMPONENT SIDE VIEW)

ELECTRIC UNIT
X34-415x-xx (J76-0169-02)

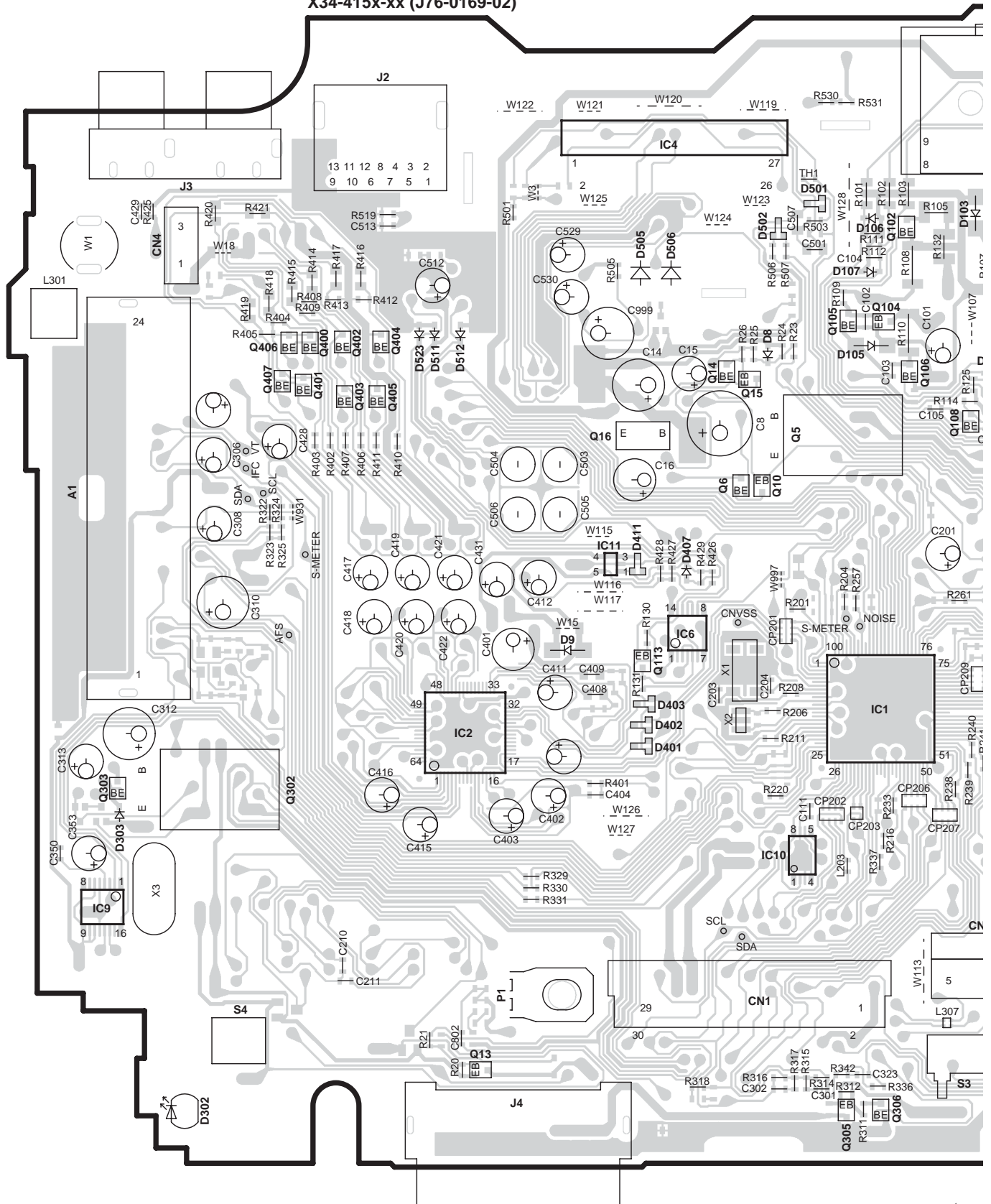

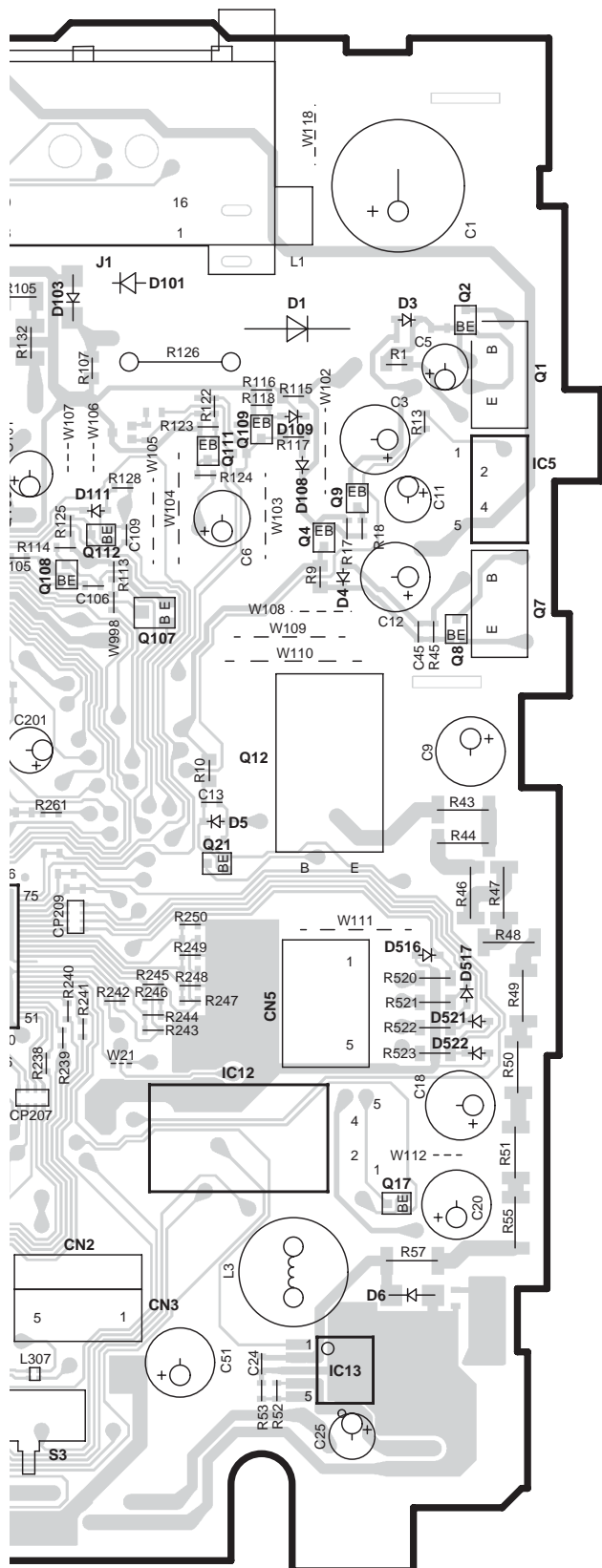

X34-415x-xx

Ref. No.	Address	Ref. No.	Address
IC1	5J	Q17	5L
IC2	5H	Q21	4K
IC4	2I	Q102	2J
IC5	3L	Q104	3J
IC6	4I	Q105	3J
IC9	6F	Q106	3J
IC10	5J	Q107	4K
IC11	4I	Q108	3J
IC12	5K	Q109	3K
IC13	6L	Q111	3K
Q1	3L	Q112	3K
Q2	2L	Q113	4I
Q4	3L	Q302	5G
Q5	3J	Q303	5F
Q6	4I	Q305	7J
Q7	3L	Q306	7J
Q8	4L	Q400	3G
Q9	3L	Q401	3G
Q10	4J	Q402	3H
Q12	4K	Q403	3H
Q13	6H	Q404	3H
Q14	3I	Q405	3H
Q15	3I	Q406	3G
Q16	3I	Q407	3G

Refer to the schematic diagram for the values of resistors and capacitors.

PC BOARD (FOIL SIDE VIEW)

ELECTRIC UNIT
X34-415x-xx (J76-0169-02)

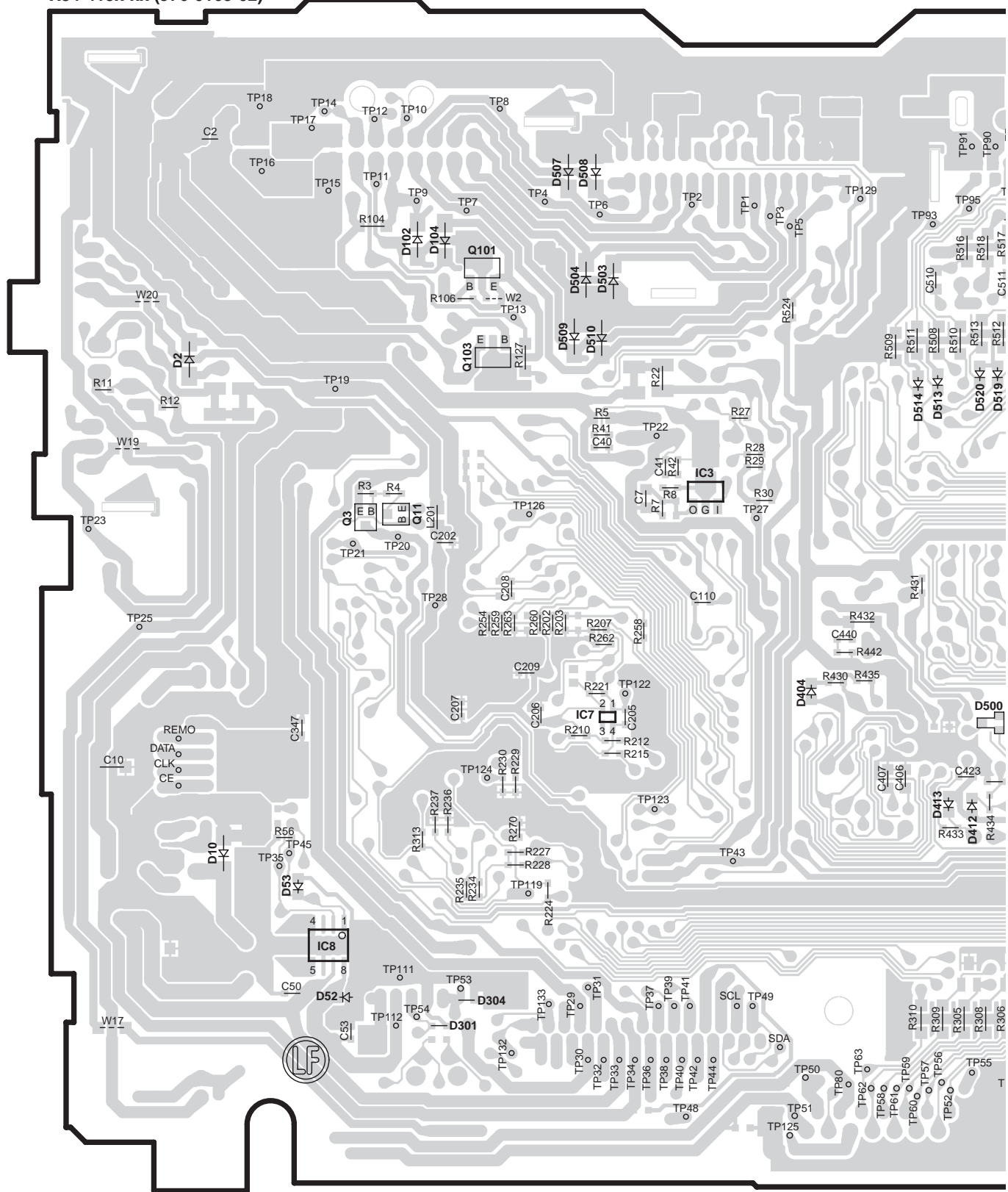

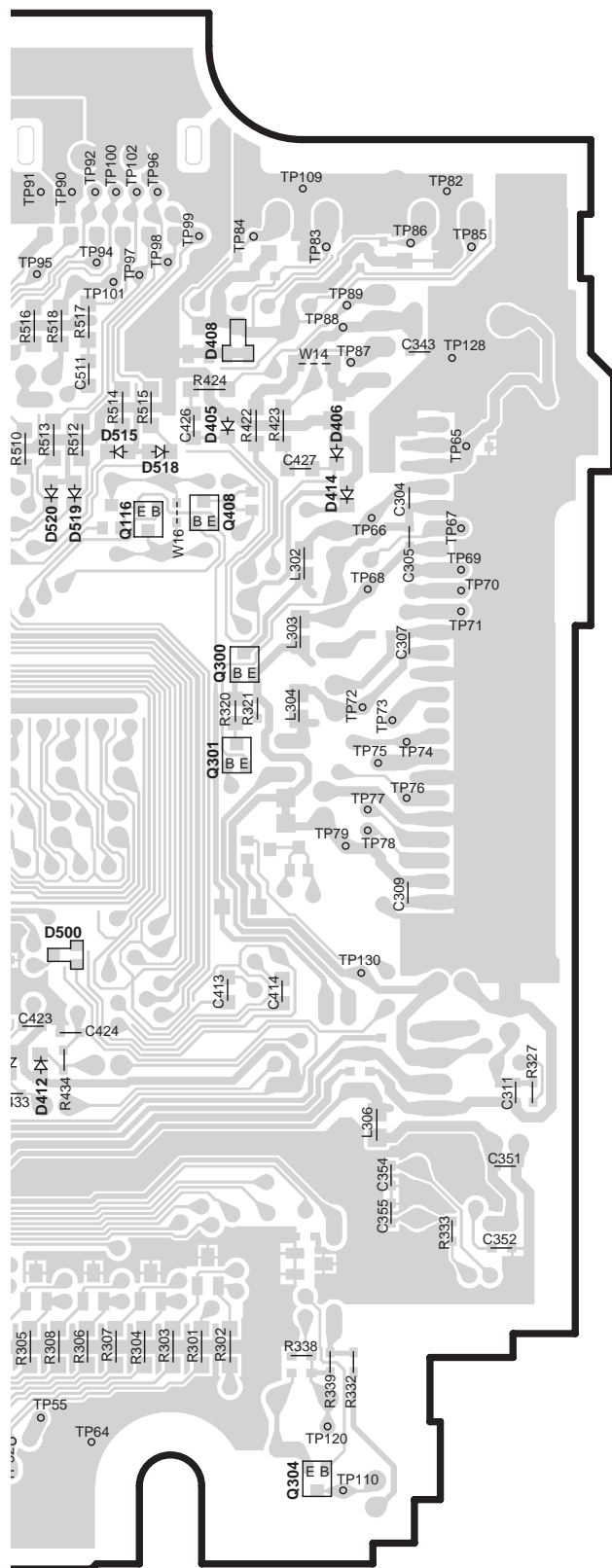

X34-415x-xx

Ref. No.	Address
IC3	4S
IC7	5S
IC8	6Q
Q3	4Q
Q11	4R
Q101	3R
Q103	3R
Q116	3U
Q300	4U
Q301	4U
Q304	6U
Q408	3U

Refer to the schematic diagram for the values of resistors and capacitors.

PC BOARD (FOIL SIDE VIEW)

CD PLAYER UNIT X32-5830-00 (J76-0184-02)

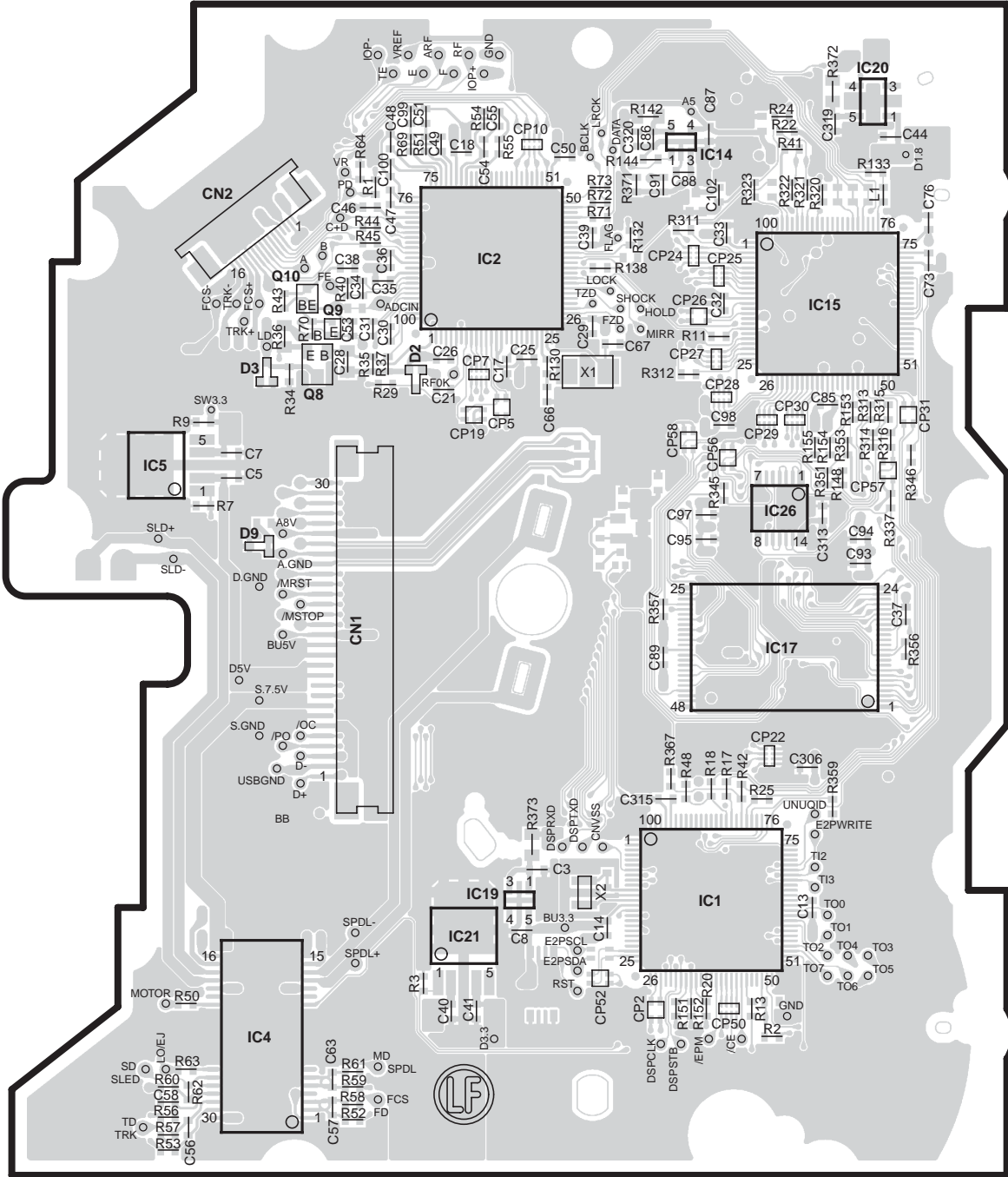

X32-5830-00

Ref. No.	Address	Ref. No.	Address
IC1	5AH	IC19	5AG
IC2	2AG	IC20	2AH
IC4	5AF	IC21	5AG
IC5	3AE	IC26	3AH
IC14	2AH	Q8	3AF
IC15	3AH	Q9	3AF
IC17	4AH	Q10	2AF

Refer to the schematic diagram for the values of resistors and capacitors.

KDC-MP632U
KDC-W6534U/UY/X590/X7533U

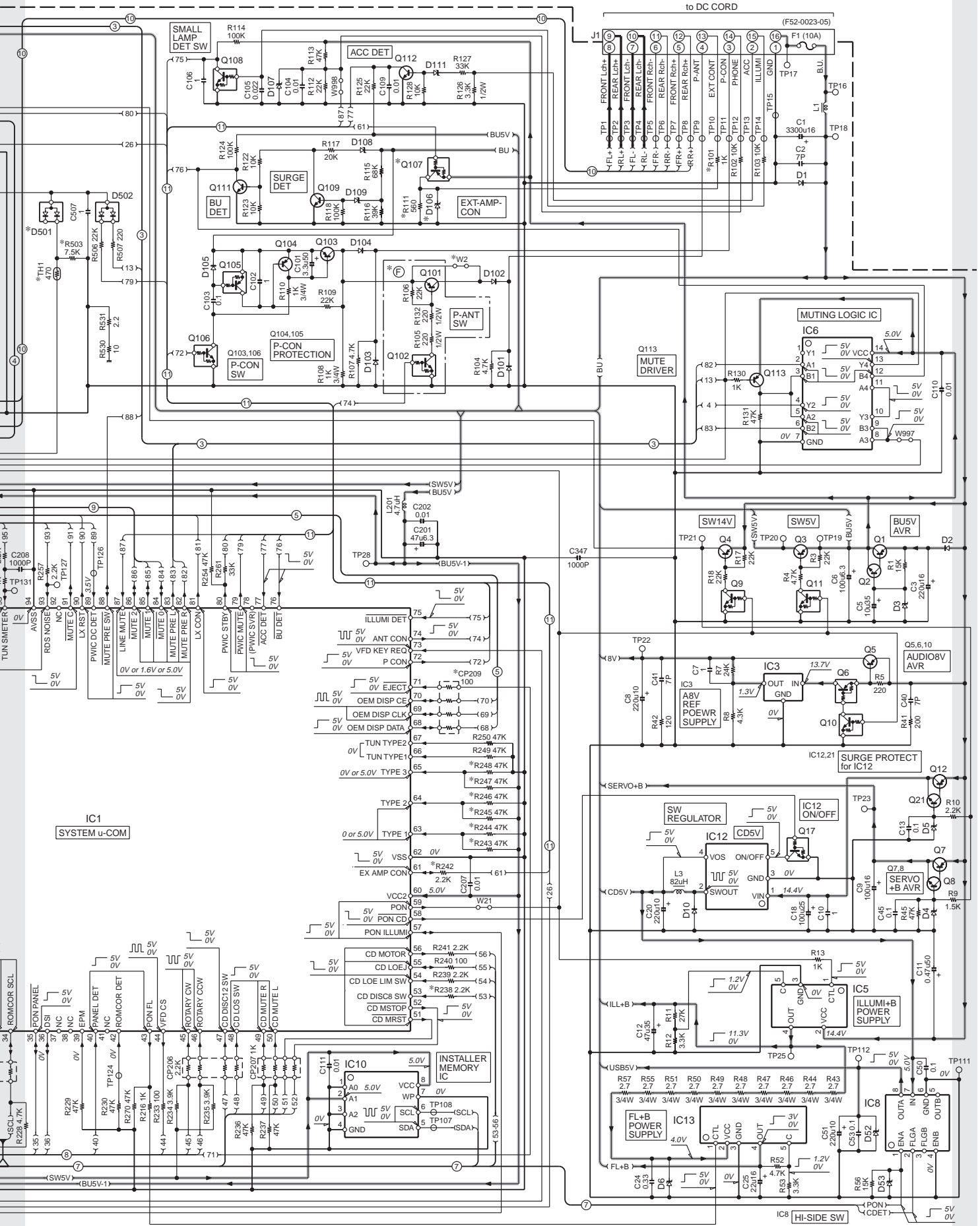

- IC1 : 30624MMPA86GP
- IC2 : E-TDA7415C
- IC3 : M5237ML-CF0J
- IC4 : F-TDA7569A
- IC5 : BA00CCWT-V5
- IC6 : SN74HC02APWR
- IC7 : S-80836CNNB-J
- IC8 : MIC2026-1YM
- IC9 : E-TDA7479AD
- IC10 : BR24L04FV-W
- IC11 : TA75S58F-F
- IC12 : SI-8050RF3NF
- IC13 : BA00CC0WFP

- Q1,5,7,302 : 2SB1565
- Q2,9,14,15,21,303 : KTC4076P(Y,GR)
- Q3,4,13,104,113 : KTA2014P(Y,GR)
- Q6,116,408 : DTA124EUA
- Q9-11,301 : DTC124EUA
- Q12 : 2SA1488NF
- Q16 : 2SB1443
- Q17,108,306 : DTC144EUA
- Q101,103 : 2SB1188(Q,R)
- Q102,106,304 : DTC114YUA
- Q105 : DTA114EUA
- Q107 : DTA123JK
- Q109,111,112 : 2SC4155A(Q,R,S)
- Q300 : 2SB1589
- Q305 : 2SA1577
- Q400-407 : DTC143TUA

- D1 : S2V60#A
- D2 : RB160L-40
- D3,106,407 : 02DZ5.6F-Y
- D4 : 02DZ8.2F-Y
- D5 : 02DZ20F-Y
- D6 : PTZ4.7B
- D8 : 02DZ12F-X
- D9,102-105,503,504,507-510 : 1SR154-400
- D10 : RB081L-20
- D52,53,108,109,405,406 : 02DZ6.8F-Y
- D101 : 10EDA20
- D107 : 02DZ4.7F-Y
- D111,414,511-523 : 02DZ6.2F-Y
- D301,304 : IMSA-6802-E
- D302 : B30-1710-05
- D303 : 02DZ9.1F-Z
- D401-403,411,500-502 : BAW56W
- D404 : UDZS3.3B
- D408 : DA204K
- D412,413 : UDZS5.6B
- D505,506 : 1SR139-400T64



DESTI- NATION	UNIT No.	(A)	(B)	(C)	(D)	(E)	(F)	C301	C343	C408	C409	CN2	CN3	CP209	D9	D106	D412	D500	D501	Q107	R101	R11,242
DPK-U077	J	0-01	YES	YES	YES	YES	YES	YES	YES	YES	YES	YES	YES	YES	YES	YES	YES	YES	YES	YES	YES	YES
DPK-MP2090U	M2	0-22	YES	YES	YES	YES	YES	YES	YES	YES	YES	YES	YES	YES	YES	YES	YES	YES	YES	YES	YES	YES
DPK-S011UUY	E3/E4	2-22	YES	YES	YES	YES	YES	YES	YES	YES	YES	YES	YES	YES	YES	YES	YES	YES	YES	YES	YES	YES
KDC-MP632U	K	0-11	YES	YES	YES	YES	YES	YES	YES	YES	YES	YES	YES	YES	YES	YES	YES	YES	YES	YES	YES	YES
KDC-X590	M1	0-10	YES	YES	YES	YES	YES	YES	YES	YES	YES	YES	YES	YES	YES	YES	YES	YES	YES	YES	YES	YES
KDC-X7533U	M1	0-21	YES	YES	YES	YES	YES	YES	YES	YES	YES	YES	YES	YES	YES	YES	YES	YES	YES	YES	YES	YES
KDC-W6534UUY	E1/E2	2-71	YES	YES	YES	YES	YES	YES	YES	YES	YES	YES	YES	YES	YES	YES	YES	YES	YES	YES	YES	YES
DPK-U077	J	0-01	YES	YES	YES	YES	YES	YES	YES	YES	YES	YES	YES	YES	YES	YES	YES	YES	YES	YES	YES	YES
DPK-MP2090U	M2	0-22	YES	YES	YES	YES	YES	YES	YES	YES	YES	YES	YES	YES	YES	YES	YES	YES	YES	YES	YES	YES
DPK-S011UUY	E3/E4	2-22	YES	YES	YES	YES	YES	YES	YES	YES	YES	YES	YES	YES	YES	YES	YES	YES	YES	YES	YES	YES
KDC-MP632U	K	0-11	YES	YES	YES	YES	YES	YES	YES	YES	YES	YES	YES	YES	YES	YES	YES	YES	YES	YES	YES	YES
KDC-X590	M1	0-10	YES	YES	YES	YES	YES	YES	YES	YES	YES	YES	YES	YES	YES	YES	YES	YES	YES	YES	YES	YES
KDC-X7533U	M1	0-21	YES	YES	YES	YES	YES	YES	YES	YES	YES	YES	YES	YES	YES	YES	YES	YES	YES	YES	YES	YES
KDC-W6534UUY	E1/E2	2-71	YES	YES	YES	YES	YES	YES	YES	YES	YES	YES	YES	YES	YES	YES	YES	YES	YES	YES	YES	YES

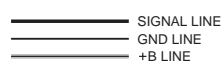

KDC-MP632U/W6534U/UY/X590/X7533U (1/2)

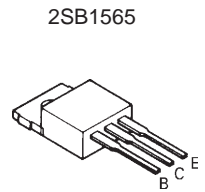

- DTA123JK
- DTC114YE
- DTC114YUA
- DTC124EE
- DTC143TUA
- DTC144EE
- 2SC4617

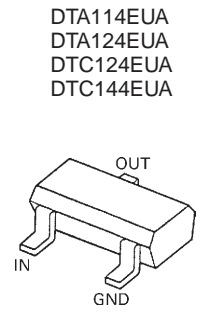
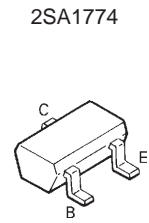
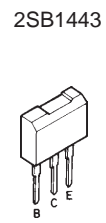
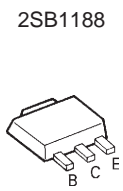

CAUTION : For continued safety, replace safety critical components only with manufacturer's recommended parts (refer to parts list).
 ⚠ Indicates safety critical components. To reduce the risk of electric shock, leakage-current or resistance measurements shall be carried out (exposed parts are acceptably insulated from the supply circuit) before the appliance is returned to the customer.

- DC voltages are as measured with a high impedance voltmeter. Values may vary slightly due to variations between individual instruments or/and units.

SWITCH UNIT (X16-3xxx-xx)

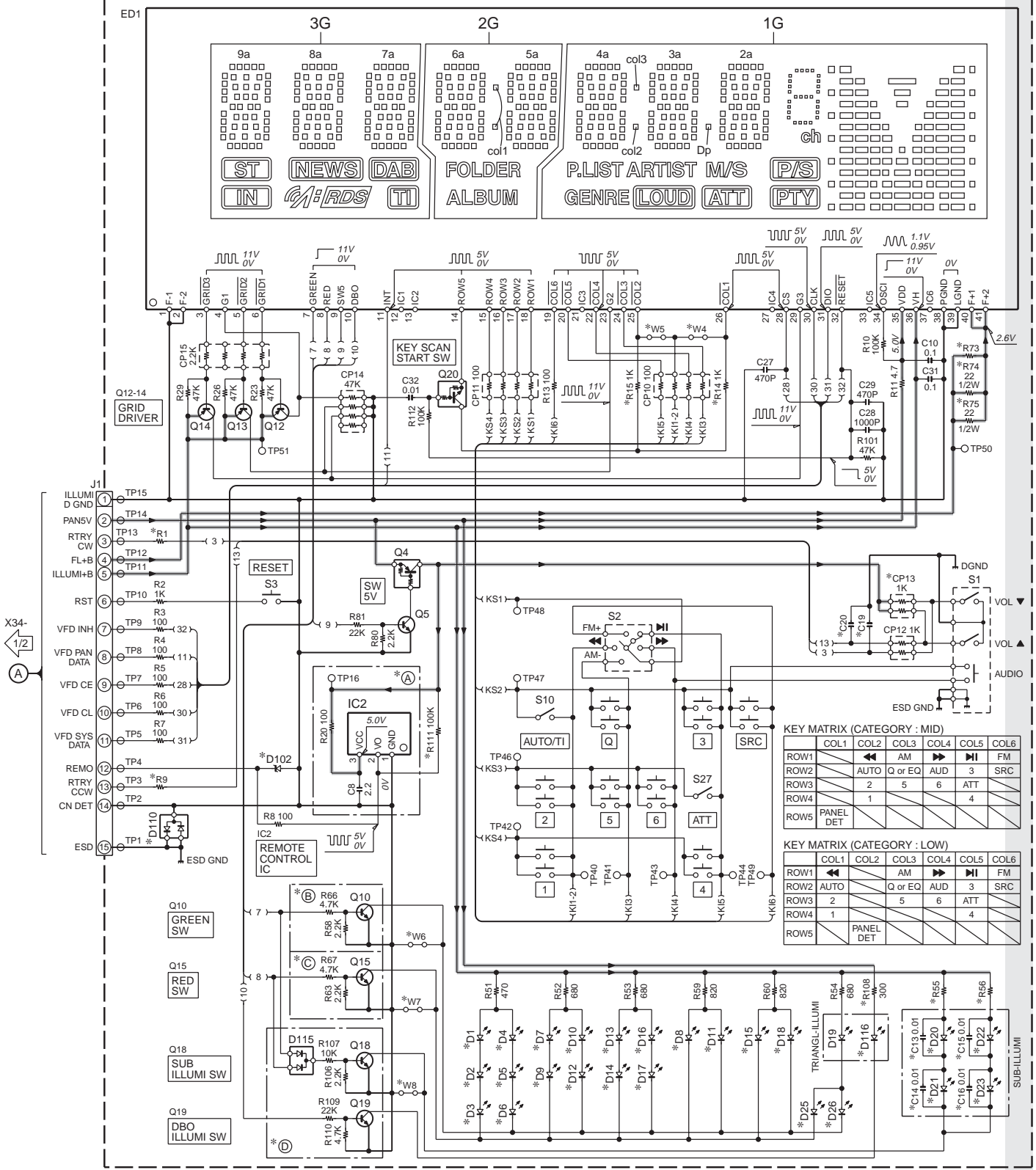

KDC-MP632U KDC-W6534U/UY/X590/X7533U



- IC2 : PNA4S22M02KW
- Q4 : RT1P141U
- Q5,10,15,18,19 : 2SC4617
- Q12-14 : 2SA1774
- Q20 : DTC144EE
- D1-3,7-9,13-15,19,25 : B30-1567-05
- D4-6,10-12,16-18,26 : *
- D20-23 : *
- D102 : UDZS5.6B
- D110 : DA204U
- D115 : DAN222
- D116 : B30-1533-05
- ED1 : 3-BT-235INK

— GND LINE
— +B LINE

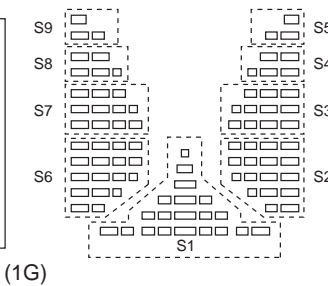
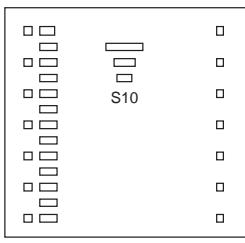
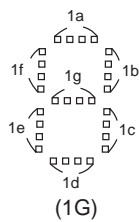
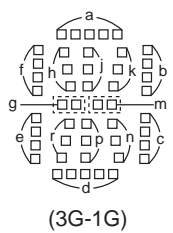

ANODE CONNECTION

PIN NAME	3G	2G	1G
P1	9a	—	2a
P2	9h	—	2h
P3	9j	—	2j
P4	9k	—	2k
P5	9b	—	2b
P6	9f	—	2f
P7	9m	—	2m
P8	9g	—	2g
P9	9c	—	2c
P10	9e	—	2e
P11	9r	—	2r
P12	9p	—	2p
P13	9n	—	2n
P14	9d	—	2d
P15	8a	6a	4a
P16	7a	5a	3a
P17	8h	6h	4h
P18	7h	5h	3h
P19	8j	6j	4j
P20	7j	5j	3j
P21	8k	6k	4k
P22	7k	5k	3k
P23	8b	6b	4b
P24	7b	5b	3b
P25	8f	6f	4f
P26	7f	5f	3f
P27	8m	6m	4m
P28	7m	5m	3m
P29	8g	6g	4g
P30	7g	5g	3g
P31	8c	6c	4c
P32	7c	5c	3c
P33	8e	6e	4e
P34	7e	5e	3e
P35	8r	6r	4r
P36	7r	5r	3r
P37	8p	6p	4p
P38	7p	5p	3p
P39	8n	6n	4n
P40	7n	5n	3n
P41	8d	6d	4d
P42	7d	5d	3d
P43	—	col1	col2
P44	—	—	col3
P45	—	—	Dp
P46	(ST)	FOLDER	P.LIST
P47	(NEWS)	ALBUM	ARTIST
P48	(DAB)	—	M/S
P49	(IN)	—	GENRE
P50	(AIRDS)	—	(LOUD)
P51	(TI)	—	(ATT)
P52	—	—	1a
P53	—	—	1b
P54	—	—	1f
P55	—	—	1g
P56	—	—	1c
P57	—	—	1e
P58	—	—	1d
P59	—	—	ch
P60	—	—	(PS)
P61	—	—	(PTY)
P62	—	—	S1
P63	—	—	S2
P64	—	—	S3
P65	—	—	S4
P66	—	—	S5
P67	—	—	S6
P68	—	—	S7
P69	—	—	S8
P70	—	—	S9
P71	—	—	S10

CATEGORY	MODEL NAME	DESTINATION	UNIT No.	(A)	(B)	(C)	(D)	C13-16	C19-20	CP13	D1-3,7-9,13-15,25	D4-6,10-12,16-18,26	D20-23	D102
USB MID	KDC-MP632U	K1	X16-3740-11	YES	—	—	—	YES	0.1	—	YES	—	B30-1729-05	YES
	KDC-X590	K	X16-3740-10	YES	—	YES	YES	YES	0.1	—	YES	—	B30-1729-05	YES
	KDC-X7533U	M1	X16-3740-21	YES	YES	YES	YES	YES	0.1	—	YES	B30-1533-05	B30-1729-05	YES
	KDC-W6534U/UY	E1/E2	X16-3742-71	YES	YES	YES	—	—	YES	0.1	—	YES	B30-1533-05	B30-1729-05
USB LOW	KDC-MP532U	K2	X16-3730-11	YES	—	—	—	YES	0.01	YES	YES	—	B30-1729-05	YES
	KDC-MP5033U	M2	X16-3730-21	YES	—	—	—	YES	0.01	YES	—	B30-1533-05	B30-1729-05	YES
	KDC-W534UA/UY	E5/E6	X16-3732-71	—	—	—	—	—	—	—	—	—	B30-1567-05	—
	KDC-W534UG/UY	E7/E8	X16-3732-72	—	—	—	—	—	0.01	YES	—	B30-1533-05	B30-1533-05	—
	KDC-W5534U/UY	E3/E4	X16-3732-70	YES	YES	YES	—	—	YES	0.01	YES	YES	B30-1533-05	B30-1729-05
U515	J	X16-3730-01	YES	—	—	—	—	YES	0.01	YES	—	B30-1575-05	B30-1729-05	YES

CATEGORY	MODEL NAME	DESTINATION	UNIT No.	D110	D116	R1,9	R14	R15,74,75	R55,56	R73	R108	R111	W4	W5	W6	W7	W8
USB MID	KDC-MP632U	K1	X16-3740-11	YES	—	100	YES	—	300	2.2 1/2W	—	—	—	YES	—	YES	YES
	KDC-X590	K	X16-3740-10	YES	YES	100	YES	—	300	2.2 1/2W	YES	—	—	YES	—	—	—
	KDC-X7533U	M1	X16-3740-21	YES	YES	100	YES	—	300	2.2 1/2W	YES	—	—	YES	—	—	YES
	KDC-W6534U/UY	E1/E2	X16-3742-71	YES	—	100	YES	—	300	2.2 1/2W	—	—	—	YES	—	—	—
USB LOW	KDC-MP532U	K2	X16-3730-11	—	—	4.7K	—	YES	300	33 1/2W	—	—	YES	—	—	YES	YES
	KDC-MP5033U	M2	X16-3730-21	—	—	4.7K	—	YES	300	33 1/2W	—	—	YES	—	—	YES	YES
	KDC-W534UA/UY	E5/E6	X16-3732-71	—	—	4.7K	—	YES	680	33 1/2W	—	YES	YES	—	—	YES	YES
	KDC-W534UG/UY	E7/E8	X16-3732-72	—	—	4.7K	—	YES	620	33 1/2W	—	YES	YES	—	—	YES	YES
	KDC-W5534U/UY	E3/E4	X16-3732-70	—	—	4.7K	—	YES	300	33 1/2W	—	—	YES	—	—	—	YES
U515	J	X16-3730-01	—	—	4.7K	—	YES	300	33 1/2W	—	—	YES	—	—	—	YES	

KDC-MP632U/W6534U/UY/X590/X7533U (2/2)

CAUTION : For continued safety, replace safety critical components only with manufacturer's recommended parts (refer to parts list).

⚠ Indicates safety critical components. To reduce the risk of electric shock, leakage-current or resistance measurements shall be carried out (exposed parts are acceptably insulated from the supply circuit) before the appliance is returned to the customer.

- DC voltages are as measured with a high impedance voltmeter. Values may vary slightly due to variations between individual instruments or/and units.

KDC-MP632U KDC-W6534U/UY/X590/X7533U

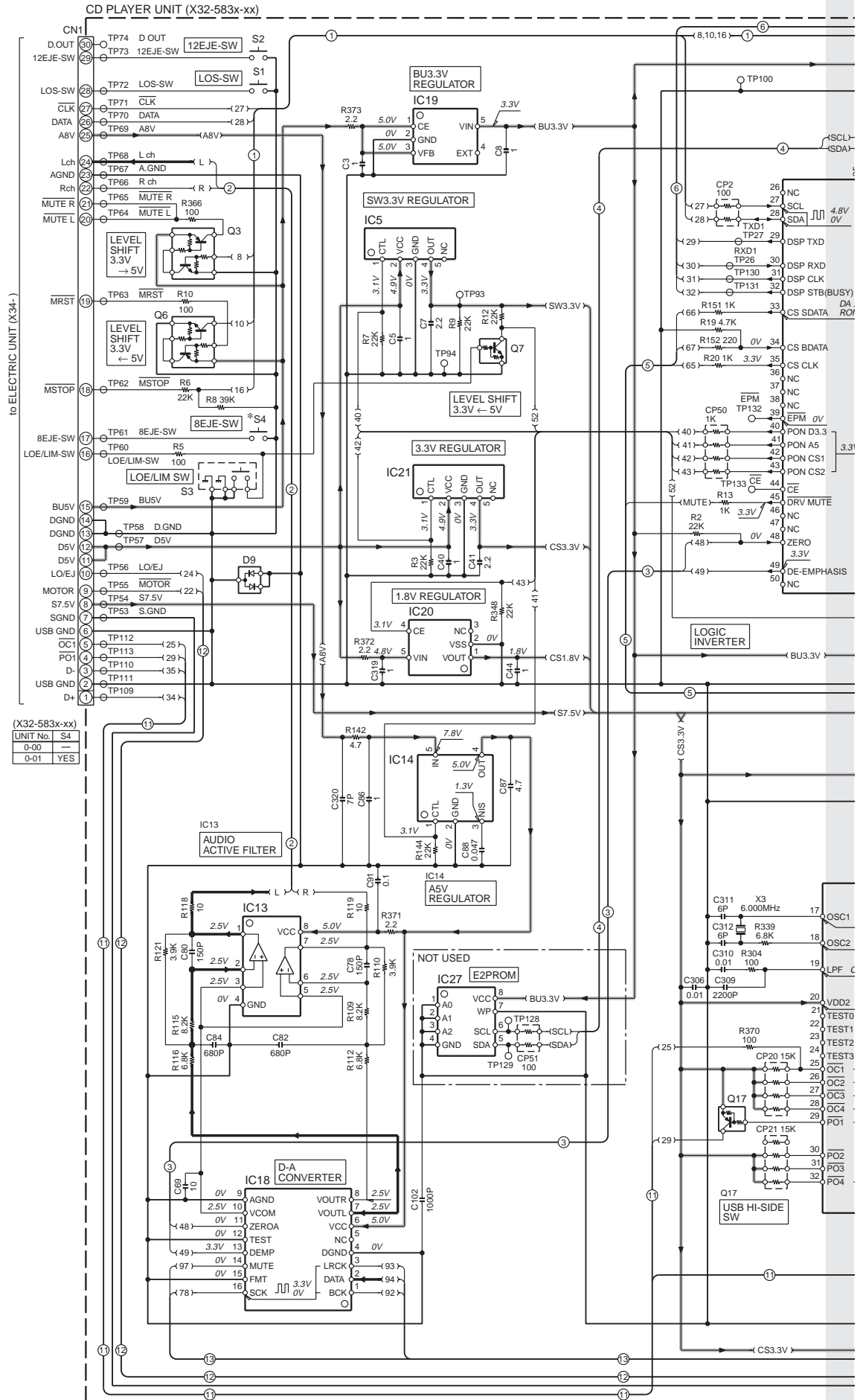

1

2

3

4

5

6

7

KDC-MP632U KDC-W6534U/UY/X590/X7533U

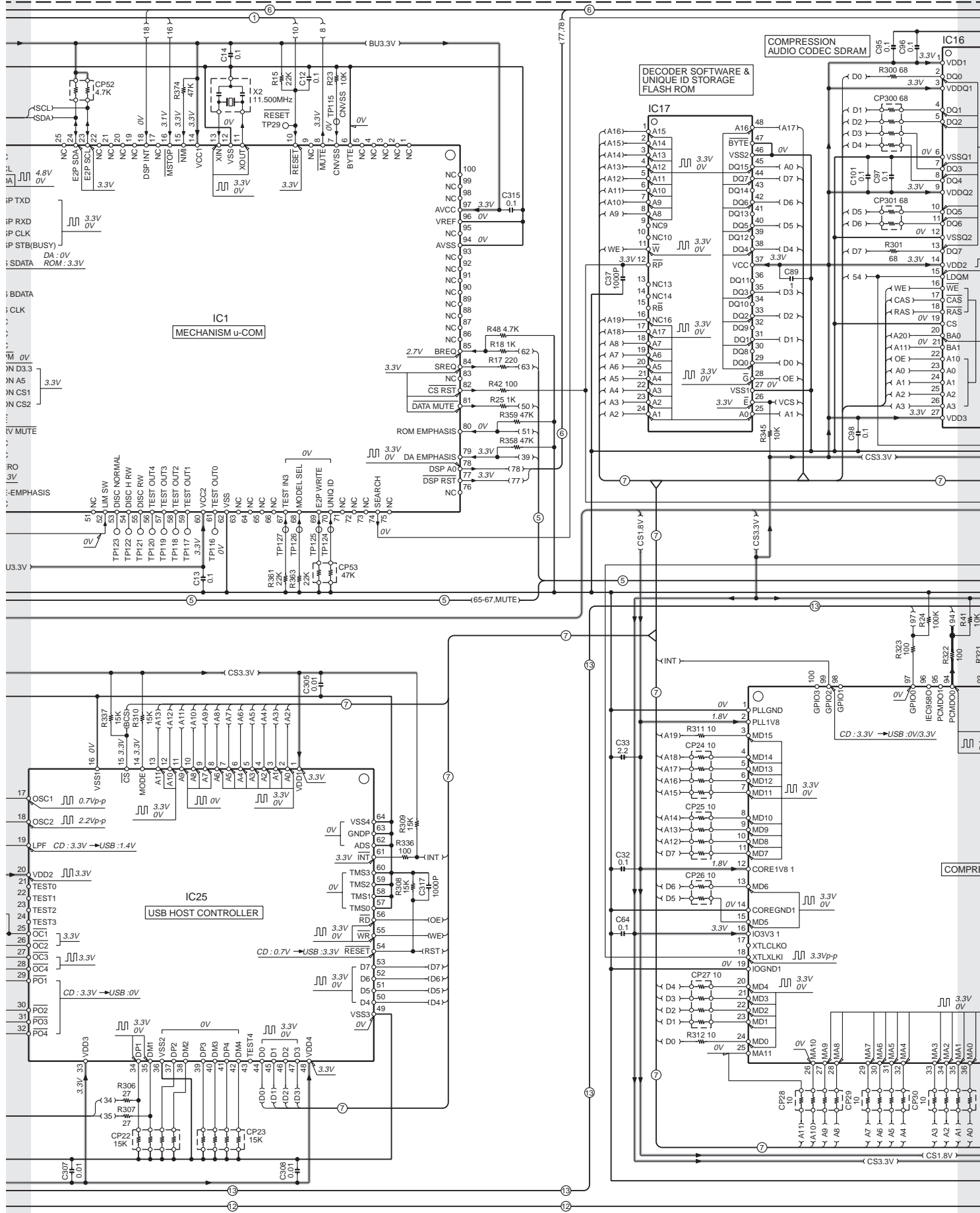

KDC-MP632U KDC-W6534U/UY/X590/X7533U

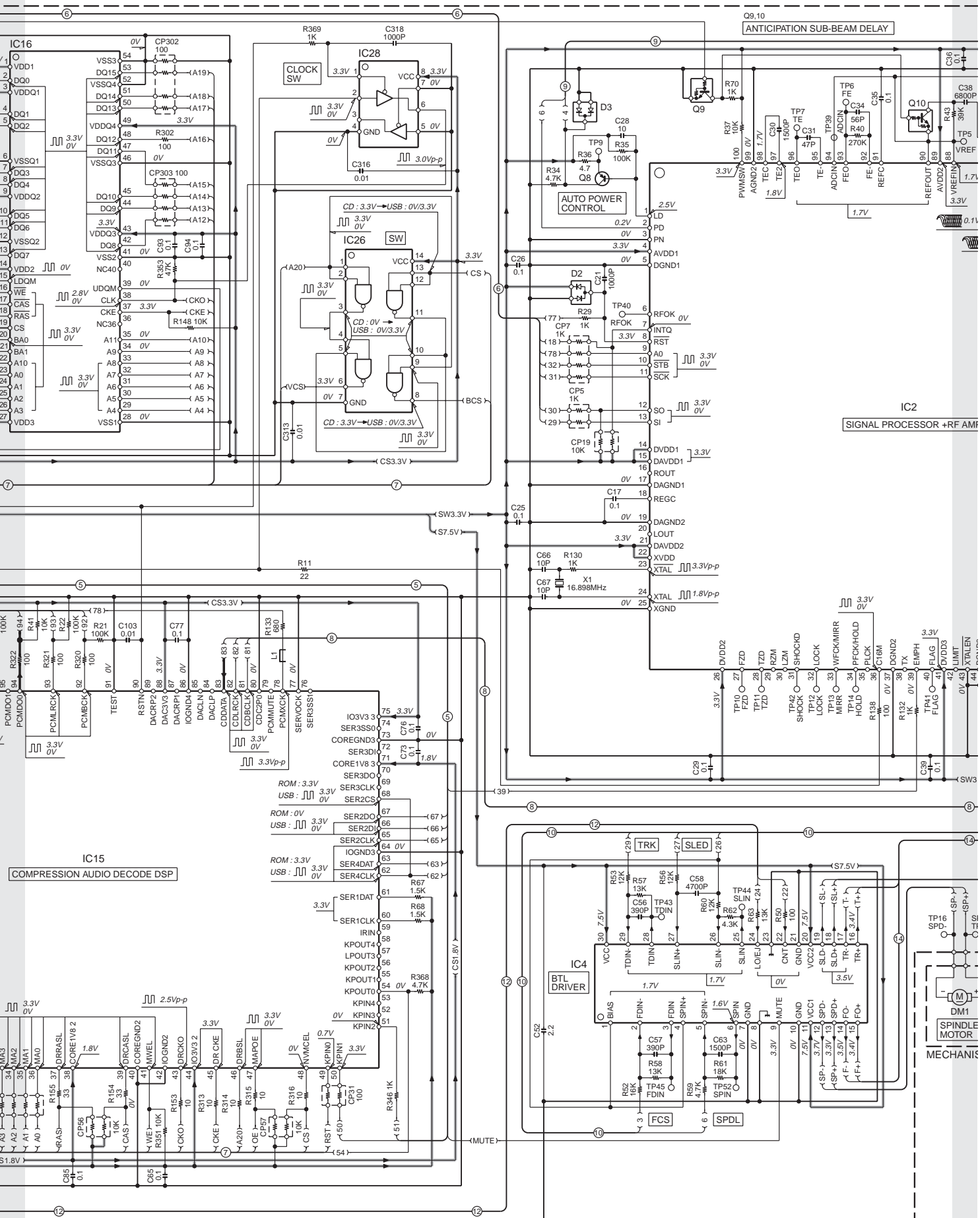

KDC-MP632U
KDC-W6534U/UY/X590/X7533U

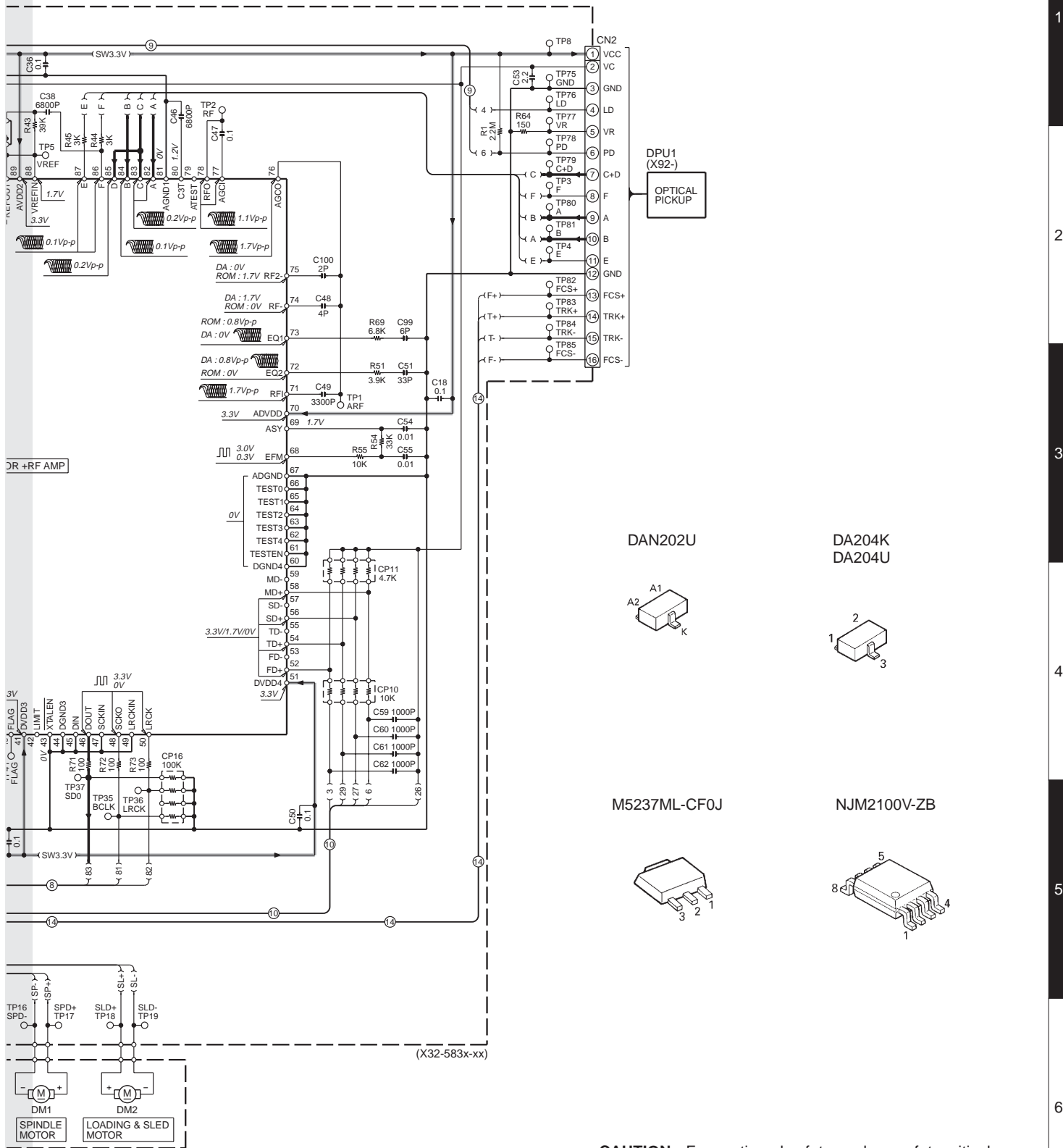

- | | |
|------------------------|-----------------|
| IC1 : M30620FCPPG | Q3 : UMD9N |
| IC2 : UPD63712GC | Q6 : UMD12N |
| IC4 : BA5824FP | Q7 : DTC124EE |
| IC5,21 : BD33KA5WFP-E2 | Q8 : 25B0970 |
| IC13 : NJM2100V-ZB | Q9 : DTC114YE |
| IC14 : TAR5S50-F | Q10 : DTC114YUA |
| IC15 : CS7410-IQZ | Q17 : DTA143XUA |
| IC16 : IC42S164007TIG | |
| IC17 : 29LV800CBT19V1 | D2,9 : DA204U |
| IC18 : PCM1754DB | D3 : DAN202U |
| IC19 : R1114N331B-TR | |
| IC20 : S-1132B18U5T1G | |
| IC25 : TDUHC1240FOC00 | |
| IC26 : TC74LCX00FT-F | |
| IC27 : NOT USED | |
| IC28 : TC7WH125FK-F | |



CAUTION : For continued safety, replace safety critical components only with manufacturer's recommended parts (refer to parts list).

⚠ Indicates safety critical components. To reduce the risk of electric shock, leakage-current or resistance measurements shall be carried out (exposed parts are acceptably insulated from the supply circuit) before the appliance is returned to the customer.

- DC voltages are as measured with a high impedance voltmeter. Values may vary slightly due to variations between individual instruments or/and units.

EXPLODED VIEW (MECHANISM)

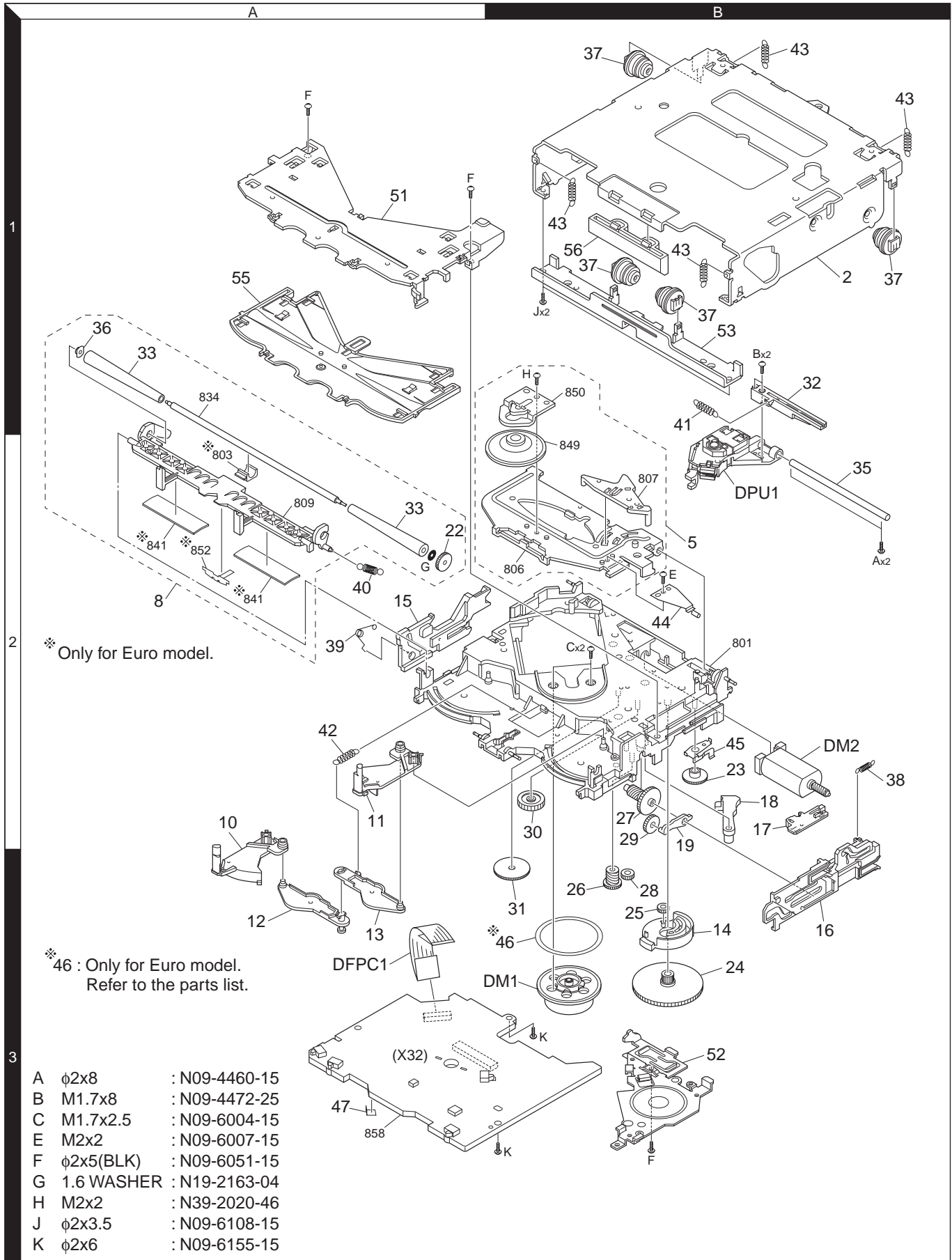

EXPLODED VIEW (UNIT)

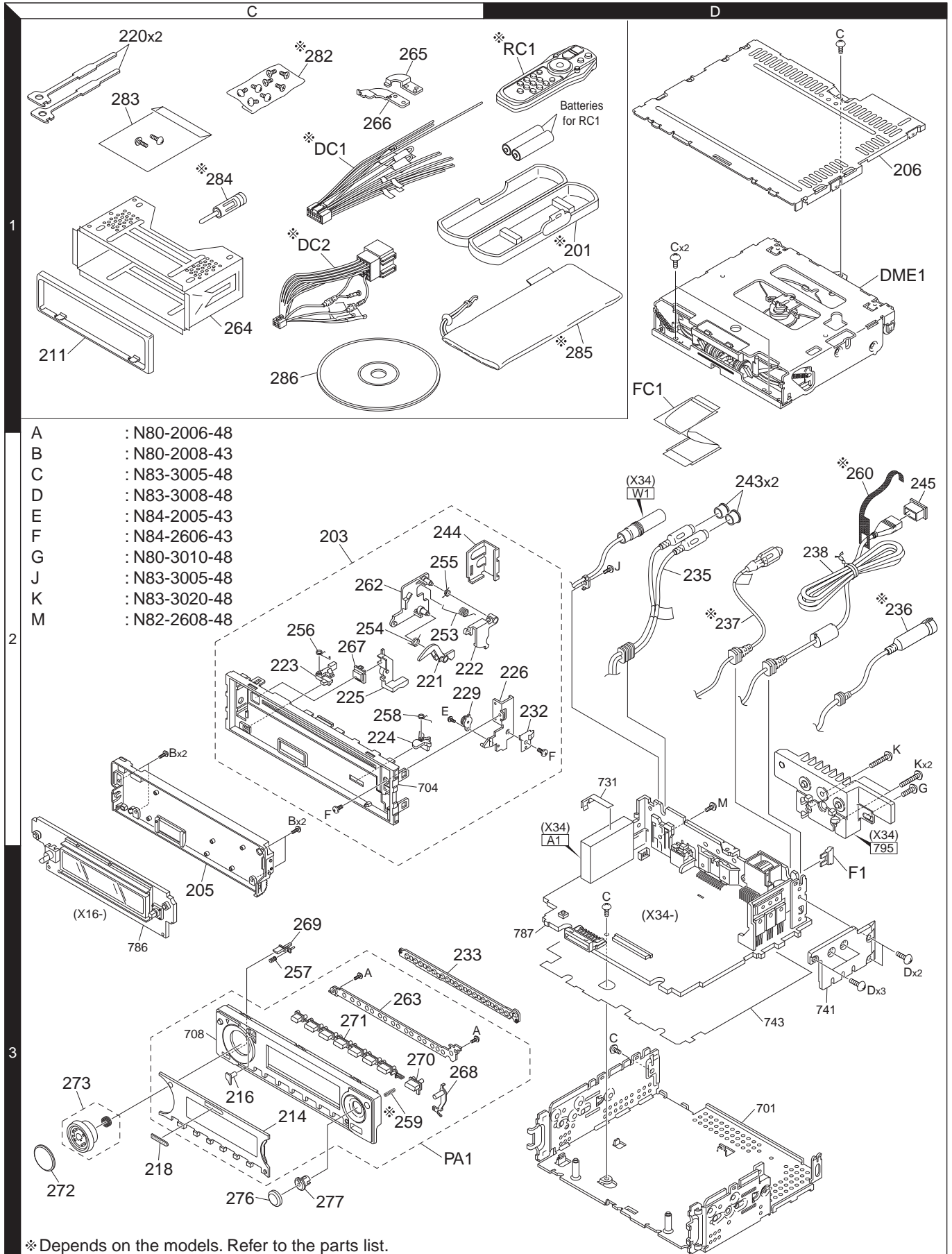

Parts with the exploded numbers larger than 700 are not supplied.

PARTS LIST

* New parts

Parts without **Parts No.** are not supplied.

Les articles non mentionnés dans le **Parts No.** ne sont pas fournis.

Teile ohne **Parts No.** werden nicht geliefert.

Ref. No.	A d	N e w	Parts No.	Description	Desti- nation	Ref. No.	A d	N e w	Parts No.	Description	Desti- nation
KDC-MP632U/W6534U/UY/X590/X7533U						244	2C		F31-0716-04	REINFORCING HARDWARE	
201	1D		A02-2743-03	PLASTIC CABINET ASSY	M1	245	2D	*	F29-0637-04	INSULATING COVER (USB)	
203	2C		A22-3059-12	SUB PANEL ASSY		F1	3D		F52-0023-05	FUSE (MINI BLADE TYPE) (10A)	
205	3C	*	A46-1833-11	REAR COVER		253	2C		G01-3246-04	TORSION COIL SPRING	
206	1D		A52-0862-02	TOP PLATE		254	2C		G01-3247-04	TORSION COIL SPRING	
PA1	3C	*	A64-3759-01	PANEL ASSY	K	255	2C		G01-3248-04	TORSION COIL SPRING	
PA1	3C	*	A64-3760-01	PANEL ASSY	K1	256	2C		G01-3249-04	TORSION COIL SPRING	
PA1	3C	*	A64-3761-01	PANEL ASSY	M1	257	3C	*	G01-4611-04	COMPRESSION SPRING (REL)	
PA1	3C	*	A64-3762-01	PANEL ASSY	E1E2	258	2C		G01-3270-04	TORSION COIL SPRING	
RC1	1D		A70-2067-15	REMOTE CONTROLLER ASSY (RC-527)	KK1M1	259	3C	*	G01-3291-04	COMPRESSION SPRING	K1E1E2
-			B46-0612-14	ID CARD	M1E1E2	-		*	H10-4983-02	POLYSTYRENE FOAMED FIXTURE	
-			B46-0681-04	ID CARD	KK1	-			H25-0329-04	PROTECTION BAG (280X450X0.03)	KK1M1
-			B46-0682-00	WARRANTY CARD	KK1M1	-			H25-0329-04	PROTECTION BAG (280X450X0.03)	E2
-			B46-0682-00	WARRANTY CARD	E1	-			H25-0337-04	PROTECTION BAG (180X300X0.03)	
-			B58-1426-04	CAUTION CARD	KK1	-			H25-1111-04	PROTECTION BAG (280X450X0.03)	E1
-		*	B59-1850-00	SUB-INSTRUCTION MANUAL		-		*	H54-3711-03	ITEM CARTON CASE (KDC-X590)	K
-		*	B64-3343-00	INST. MANUAL (ENG.FRE.SPA)	KK1	-		*	H54-3712-03	ITEM CARTON CASE (KDC-MP632U)	K1
-		*	B64-3344-00	INST. MANUAL (ENG.T-CHI)	M1	-		*	H54-3713-03	ITEM CARTON CASE (KDC-X7533U)	M1
-		*	B64-3345-00	INST. MANUAL (ARABIC)	M1	-		*	H54-3714-03	ITEM CARTON CASE (KDC-W6534U)	E1
-		*	B64-3346-00	INST. MANUAL (ENGLISH)	E1E2	-		*	H54-3715-03	ITEM CARTON CASE (KDC-W6534UY)	E2
-		*	B64-3347-00	INST. MANUAL (FRE.GER.DUT)	E1	260	2D	*	H30-0594-04	MAGIC TAPE	KK1
-		*	B64-3348-00	INST. MANUAL (ITA.SPA.POR)	E1	262	2C		J19-7049-03	HOLDER	
-		*	B64-3349-00	INST. MANUAL (RUSSIAN)	E2	263	3C	*	J19-7112-02	HOLDER	
211	1C		B07-3125-01	ESCUTCHEON	KM1E1	264	1C		J22-0011-03	MOUNTING HARDWARE ASSY	
211	1C		B07-3125-01	ESCUTCHEON	E2	265	1C		J22-0258-04	MOUNTING HARDWARE (L)	
211	1C		B07-3126-01	ESCUTCHEON	K1	266	1C		J22-0259-04	MOUNTING HARDWARE (R)	
214	3C	*	B10-4762-02	FRONT GLASS	K	267	2C		K24-4282-04	PUSH KNOB (EJECT)	
214	3C	*	B10-4763-02	FRONT GLASS	K1	268	3C	*	K24-4460-03	PUSH KNOB (AME)	KK1E1
214	3C	*	B10-4764-02	FRONT GLASS	M1	268	3C	*	K24-4460-03	PUSH KNOB (AME)	E2
214	3C	*	B10-4765-02	FRONT GLASS	E1E2	268	3C		K24-4461-03	PUSH KNOB (AME)	K1
216	3C		B19-2364-04	LIGHTING BOARD (REMOTE)		269	3C	*	K24-4464-03	PUSH KNOB (RELEASE)	
218	3C		B43-1518-04	BADGE		270	3C		K24-4462-03	PUSH KNOB (SRC)	
220	1C		D10-4589-04	LEVER		271	3C	*	K25-1784-02	PUSH KNOB (PRESET)	
221	2C		D10-4865-03	LEVER (PUSH)		272	3C		K28-0103-03	KEY TOP (VOL)	
222	2C		D10-4866-03	LEVER (HOOK)		273	3C	*	K28-0167-03	KNOB ASSY (VOL)	E1E2
223	2C		D10-4867-04	LEVER (LOCK)		273	3C		K29-7200-03	KNOB ASSY (VOL)	KK1M1
224	2C		D10-4868-04	LEVER (DETECT)		276	3C		K28-0106-03	KEY TOP (FM/AM)	
225	2C		D10-4869-03	LEVER (EJECT)		277	3C	*	K28-0122-03	KNOB BASE (FM/AM)	
226	2D		D10-4870-04	ARM ASSY		282	1C		N99-1757-05	SCREW SET	KK1M1
229	2C		D39-0255-05	DAMPER		283	1C	*	N99-1780-05	SCREW SET	
232	2D		E29-2028-04	LEAD PLATE		A	3C		N80-2006-48	PAN HEAD TAPTITE SCREW	
233	3C	*	E29-2067-03	CONDUCTIVE RUBBER		B	2C		N80-2008-43	PAN HEAD TAPTITE SCREW	
235	2D		E30-6290-15	CORD WITH PINPLUG (PREOUT)	KM1	C	1D		N83-3005-48	PAN HEAD TAPTITE SCREW	
235	2D		E30-6291-15	CORD WITH PINPLUG (AUX)	K1E1E2	D	3D		N83-3008-48	PAN HEAD TAPTITE SCREW	
236	2D		E30-6420-05	CORD WITH DIN CONNECTOR (OPEL)	E1E2	E	2C		N84-2005-43	PAN HEAD TAPTITE SCREW	
237	2D	*	E30-6584-05	CORD WITH CONNECTOR (WIRED R.)	K	F	2D		N84-2606-43	PAN HEAD TAPTITE SCREW	
238	2D	*	E30-6588-05	CORD WITH CONNECTOR (USB) (1m)		284	1C		T90-0523-05	ANTENNA ADAPTOR	E1E2
△ DC1	1C		E30-6408-05	DC CORD	KM1	285	1D		W01-1661-05	CARRYING CASE	K1E1E2
△ DC1	1C		E30-6414-05	DC CORD	K1	285	1D	*	W01-1664-05	CARRYING CASE	K
△ DC2	1C		E30-6412-05	DC CORD	E1E2	286	1C	*	W01-1673-05	COMPACT DISC	KK1M1
FC1	1D	*	E39-0814-05	FLAT CABLE		286	1C	*	W01-1674-05	COMPACT DISC	E1E2
243	2D		F29-0626-04	INSULATING COVER (PREOUT/AUX)							

K: KDC-X590 K1: KDC-MP632U M1: KDC-X7533U E1: KDC-W6534U E2: KDC-W6534UY
(E : Europe K : North America M : Other Areas W : Without Europe)

△ Indicates safety critical components.

PARTS LIST

KDC-MP632U/W6534U/UY/X590/X7533U

Ref. No.	Add	New	Parts No.	Description	Destination
DME1	1D	*	X92-5440-00	MECHANISM ASSY (DXM-6810W)	KK1M1
DME1	1D	*	X92-5440-04	MECHANISM ASSY (DXM-6814W)	E1E2
SWITCH UNIT (X16-374x-xx)					
D1-3			B30-1567-05	LED (1608,RED)	
D4-6			B30-1533-05	LED (1608,PG)	M1E1E2
D7-9			B30-1567-05	LED (1608,RED)	
D10-12			B30-1533-05	LED (1608,PG)	M1E1E2
D13-15			B30-1567-05	LED (1608,RED)	
D16-18			B30-1533-05	LED (1608,PG)	M1E1E2
D19			B30-1567-05	LED (1608,RED)	
D20-23			B30-1729-05	LED (1608,BLUE)	
D25			B30-1567-05	LED (1608,RED)	
D26			B30-1533-05	LED (1608,PG)	M1E1E2
D116			B30-1533-05	LED (1608,PG)	KM1
C8			CK73FB1A225K	CHIP C 2.2UF K	
C10			CK73GB1H104K	CHIP C 0.10UF K	
C13-16			CK73GB1H103K	CHIP C 0.010UF K	
C19,20			CK73GB1H104K	CHIP C 0.10UF K	
C27			CC73GCH1H471J	CHIP C 470PF J	
C28			CK73GB1H102K	CHIP C 1000PF K	
C29			CC73GCH1H471J	CHIP C 470PF J	
C31			CK73GB1H104K	CHIP C 0.10UF K	
C32			CK73GB1H103K	CHIP C 0.010UF K	
J1			E59-0851-05	RECTANGULAR PLUG	
CP10,11			RK74HB1J101J	CHIP-COM 100 J 1/16W	
CP12			RK74GA1J102J	CHIP-COM 1.0K J 1/16W	
CP14			RK74HB1J473J	CHIP-COM 47K J 1/16W	
CP15			RK74HB1J222J	CHIP-COM 2.2K J 1/16W	
R1			RK73EB2E101J	CHIP R 100 J 1/4W	
R2			RK73EB2E102J	CHIP R 1.0K J 1/4W	
R3-9			RK73EB2E101J	CHIP R 100 J 1/4W	
R10			RK73GB2A104J	CHIP R 100K J 1/10W	
R11			RK73GB2A4R7J	CHIP R 4.7 J 1/10W	
R13,14			RK73GB2A102J	CHIP R 1.0K J 1/10W	
R20			RK73GB2A101J	CHIP R 100 J 1/10W	
R23			RK73GB2A473J	CHIP R 47K J 1/10W	
R26			RK73GB2A473J	CHIP R 47K J 1/10W	
R29			RK73GB2A473J	CHIP R 47K J 1/10W	
R51			RK73FB2B471J	CHIP R 470 J 1/8W	
R52-54			RK73EB2E681J	CHIP R 680 J 1/4W	
R55,56			RK73EB2E301J	CHIP R 300 J 1/4W	
R58			RK73GB2A222J	CHIP R 2.2K J 1/10W	M1E1E2
R59,60			RK73EB2E821J	CHIP R 820 J 1/4W	
R63			RK73GB2A222J	CHIP R 2.2K J 1/10W	KM1E1
R63			RK73GB2A222J	CHIP R 2.2K J 1/10W	E2
R66,67			RK73GB2A472J	CHIP R 4.7K J 1/10W	M1E1E2
R67			RK73GB2A472J	CHIP R 4.7K J 1/10W	K
R73			RK73PB2H2R2J	CHIP R 2.2 J 1/2W	
R80			RK73GB2A222J	CHIP R 2.2K J 1/10W	
R81			RK73GB2A223J	CHIP R 22K J 1/10W	
R101			RK73GB2A473J	CHIP R 47K J 1/10W	
R106			RK73GB2A222J	CHIP R 2.2K J 1/10W	KM1
R107			RK73GB2A103J	CHIP R 10K J 1/10W	KM1

Ref. No.	Add	New	Parts No.	Description	Destination
R108			RK73GB2A301J	CHIP R 300 J 1/10W	KM1
R109			RK73GB2A223J	CHIP R 22K J 1/10W	KM1
R110			RK73GB2A472J	CHIP R 4.7K J 1/10W	KM1
R112			RK73GB2A104J	CHIP R 100K J 1/10W	
W5			R92-1252-05	CHIP R 0 OHM J 1/16W	
W7,8			R92-1252-05	CHIP R 0 OHM J 1/16W	K1
W8			R92-1252-05	CHIP R 0 OHM J 1/16W	E1E2
S2			S70-0106-05	TACT SWITCH	
S10		*	S70-0939-05	TACT SWITCH	
S27		*	S70-0939-05	TACT SWITCH	
S1			T99-0457-15	ROTARY ENCODER	
D102			UDZS5.6B	ZENER DIODE	
D110			DA204U	DIODE	
D115			DAN222	DIODE	KM1
ED1			3-BT-235INK	FLUORESCENT INDICATOR TUBE	
IC2			PNA4S22M02KW	ANALOGUE IC	
Q4			RT1P141U	TRANSISTOR	
Q5			2SC4617	TRANSISTOR	
Q10			2SC4617	TRANSISTOR	M1E1E2
Q12-14			2SA1774	TRANSISTOR	
Q15			2SC4617	TRANSISTOR	KM1E1
Q15			2SC4617	TRANSISTOR	E2
Q18,19			2SC4617	TRANSISTOR	KM1
Q20			DTC144EE	DIGITAL TRANSISTOR	
CD PLAYER UNIT (X32-5830-00)					
C3			CK73GB1A105K	CHIP C 1.0UF K	
C5			CK73GB1A105K	CHIP C 1.0UF K	
C7			CK73GB0J225K	CHIP C 2.2UF K	
C8			CK73GB1A105K	CHIP C 1.0UF K	
C12-14			CK73GB1H104K	CHIP C 0.10UF K	
C17,18			CK73GB1H104K	CHIP C 0.10UF K	
C21			CK73GB1H102K	CHIP C 1000PF K	
C25,26			CK73GB1H104K	CHIP C 0.10UF K	
C28			CK73FB0J106K	CHIP C 10UF K	
C29			CK73GB1H104K	CHIP C 0.10UF K	
C30			CK73GB1H152K	CHIP C 1500PF K	
C31			CC73GCH1H470J	CHIP C 47PF J	
C32			CK73GB1H104K	CHIP C 0.10UF K	
C33			CK73GB0J225K	CHIP C 2.2UF K	
C34			CC73GCH1H560J	CHIP C 56PF J	
C35,36			CK73GB1H104K	CHIP C 0.10UF K	
C37			CK73GB1H102K	CHIP C 1000PF K	
C38			CK73GB1H682K	CHIP C 6800PF K	
C39			CK73GB1H104K	CHIP C 0.10UF K	
C40			CK73GB1A105K	CHIP C 1.0UF K	
C41			CK73GB0J225K	CHIP C 2.2UF K	
C44			CK73GB1A105K	CHIP C 1.0UF K	
C46			CK73GB1H682K	CHIP C 6800PF K	
C47			CK73GB1H104K	CHIP C 0.10UF K	
C48			CC73GCH1H040C	CHIP C 4.0PF C	
C49			CK73GB1H332K	CHIP C 3300PF K	
C50			CK73GB1H104K	CHIP C 0.10UF K	
C51			CC73GCH1H330J	CHIP C 33PF J	

K: KDC-X590 K1: KDC-MP632U M1: KDC-X7533U E1: KDC-W6534U E2: KDC-W6534UY
(E : Europe K : North America M : Other Areas W : Without Europe)

△ Indicates safety critical components.

PARTS LIST

CD PLAYER UNIT (X32-5830-00)

Ref. No.	A	N	Parts No.	Description	Desti-	Ref. No.	A	N	Parts No.	Description	Desti-
	d	e			nation		d	e			nation
C52			CK73FB1A225K	CHIP C 2.2UF K		CP27-30			RK74HB1J100J	CHIP-COM 10 J 1/16W	
C53			CK73GB0J225K	CHIP C 2.2UF K		CP31			RK74GA1J101J	CHIP-COM 100 J 1/16W	
C54,55			CK73GB1H103K	CHIP C 0.010UF K		CP50			RK74HB1J102J	CHIP-COM 1.0K J 1/16W	
C56,57			CC73GCH1H391J	CHIP C 390PF J		CP52			RK74GA1J472J	CHIP-COM 4.7K J 1/16W	
C58			CK73GB1H472K	CHIP C 4700PF K		CP53			RK74GA1J473J	CHIP-COM 47K J 1/16W	
C59-62			CK73GB1H102K	CHIP C 1000PF K		CP56,57			RK74GA1J103J	CHIP-COM 10K J 1/16W	
C63			CK73GB1H152K	CHIP C 1500PF K		CP300		*	RK74HB1J680J	CHIP-COM 68 J 1/16W	
C64,65			CK73GB1H104K	CHIP C 0.10UF K		CP301			RK74GA1J680J	CHIP-COM 68 J 1/16W	
C66,67			CC73GCH1H100D	CHIP C 10PF D		CP302,303			RK74HB1J101J	CHIP-COM 100 J 1/16W	
C69			CK73FB0J106K	CHIP C 10UF K		R1			RK73GB2A225J	CHIP R 2.2M J 1/10W	
C73			CK73GB1H104K	CHIP C 0.10UF K		R2,3			RK73GB2A223J	CHIP R 22K J 1/10W	
C76,77			CK73GB1H104K	CHIP C 0.10UF K		R5			RK73GB2A101J	CHIP R 100 J 1/10W	
C78			CC73GCH1H151J	CHIP C 150PF J		R6			RK73GH2A223D	CHIP R 22K D 1/10W	
C80			CC73GCH1H151J	CHIP C 150PF J		R7			RK73GB2A223J	CHIP R 22K J 1/10W	
C82			CC73GCH1H681J	CHIP C 680PF J		R8			RK73GH2A393D	CHIP R 39K D 1/10W	
C84			CC73GCH1H681J	CHIP C 680PF J		R9			RK73GB2A223J	CHIP R 22K J 1/10W	
C85			CK73GB1H104K	CHIP C 0.10UF K		R10			RK73GB2A101J	CHIP R 100 J 1/10W	
C86			CK73GB1A105K	CHIP C 1.0UF K		R11			RK73GB2A220J	CHIP R 22 J 1/10W	
C87			CK73GB0J475K	CHIP C 4.7UF K		R12			RK73GB2A223J	CHIP R 22K J 1/10W	
C88			CK73GB1H473K	CHIP C 0.047UF K		R13			RK73GB2A102J	CHIP R 1.0K J 1/10W	
C89			CK73GB1A105K	CHIP C 1.0UF K		R15			RK73GB2A223J	CHIP R 22K J 1/10W	
C91			CK73GB1H104K	CHIP C 0.10UF K		R17			RK73GB2A221J	CHIP R 220 J 1/10W	
C93-98			CK73GB1H104K	CHIP C 0.10UF K		R18			RK73GB2A102J	CHIP R 1.0K J 1/10W	
C99			CC73GCH1H060D	CHIP C 6.0PF D		R19			RK73GB2A472J	CHIP R 4.7K J 1/10W	
C100			CC73GCH1H020C	CHIP C 2.0PF C		R20			RK73GB2A102J	CHIP R 1.0K J 1/10W	
C101			CK73GB1H104K	CHIP C 0.10UF K		R21,22			RK73GB2A104J	CHIP R 100K J 1/10W	
C102			CK73GB1H102K	CHIP C 1000PF K		R23			RK73GB2A103J	CHIP R 10K J 1/10W	
C103			CK73GB1H103K	CHIP C 0.010UF K		R24			RK73GB2A104J	CHIP R 100K J 1/10W	
C305-308			CK73GB1H103K	CHIP C 0.010UF K		R25			RK73GB2A102J	CHIP R 1.0K J 1/10W	
C309			CK73GB1H222K	CHIP C 2200PF K		R29			RK73GB2A102J	CHIP R 1.0K J 1/10W	
C310			CK73GB1H103K	CHIP C 0.010UF K		R34			RK73GB2A472J	CHIP R 4.7K J 1/10W	
C311,312			CC73GCH1H060D	CHIP C 6.0PF D		R35			RK73GB2A104J	CHIP R 100K J 1/10W	
C313			CK73GB1H103K	CHIP C 0.010UF K		R36			RK73FB2B4R7J	CHIP R 4.7 J 1/8W	
C315			CK73GB1H104K	CHIP C 0.10UF K		R37			RK73GB2A103J	CHIP R 10K J 1/10W	
C316			CK73GB1H103K	CHIP C 0.010UF K		R40			RK73GB2A274J	CHIP R 270K J 1/10W	
C317,318			CK73GB1H102K	CHIP C 1000PF K		R41			RK73GB2A103J	CHIP R 10K J 1/10W	
C319			CK73GB1A105K	CHIP C 1.0UF K		R42			RK73GB2A101J	CHIP R 100 J 1/10W	
C320			CC73GCH1H070D	CHIP C 7.0PF D		R43			RK73GB2A393J	CHIP R 39K J 1/10W	
CN1	*		E41-2630-05	FLAT CABLE CONNECTOR		R44,45			RK73GB2A302J	CHIP R 3.0K J 1/10W	
CN2			E41-2612-05	FLAT CABLE CONNECTOR		R48			RK73GB2A472J	CHIP R 4.7K J 1/10W	
L1	*		L92-0615-05	CHIP FERRITE		R50			RK73GB2A101J	CHIP R 100 J 1/10W	
X1			L77-2863-05	CRYSTAL RESONATOR (16.899MHZ)		R51			RK73GB2A392J	CHIP R 3.9K J 1/10W	
X2	*		L78-1215-05	RESONATOR (11.500MHZ)		R52			RK73GB2A163J	CHIP R 16K J 1/10W	
X3	*		L77-2923-05	CRYSTAL RESONATOR (6.000MHZ)		R53			RK73GB2A123J	CHIP R 12K J 1/10W	
CP2			RK74GA1J101J	CHIP-COM 100 J 1/16W		R54			RK73GB2A333J	CHIP R 33K J 1/10W	
CP5			RK74GA1J102J	CHIP-COM 1.0K J 1/16W		R55			RK73GB2A103J	CHIP R 10K J 1/10W	
CP7			RK74HB1J102J	CHIP-COM 1.0K J 1/16W		R56			RK73GB2A123J	CHIP R 12K J 1/10W	
CP10			RK74HB1J103J	CHIP-COM 10K J 1/16W		R57,58			RK73GB2A133J	CHIP R 13K J 1/10W	
CP11			RK74HB1J472J	CHIP-COM 4.7K J 1/16W		R59			RK73GB2A472J	CHIP R 4.7K J 1/10W	
CP16			RK74HB1J104J	CHIP-COM 100K J 1/16W		R60			RK73GB2A123J	CHIP R 12K J 1/10W	
CP19			RK74GA1J103J	CHIP-COM 10K J 1/16W		R61			RK73GB2A183J	CHIP R 18K J 1/10W	
CP20-23	*		RK74HB1J153J	CHIP-COM 15K J 1/16W		R62			RK73GB2A432J	CHIP R 4.3K J 1/10W	
CP24,25			RK74HB1J100J	CHIP-COM 10 J 1/16W		R63			RK73GB2A133J	CHIP R 13K J 1/10W	
CP26	*		RK74GA1J100J	CHIP-COM 10 J 1/16W		R64			RK73GB2A151J	CHIP R 150 J 1/10W	
						R67,68			RK73GB2A152J	CHIP R 1.5K J 1/10W	

K: KDC-X590 K1: KDC-MP632U M1: KDC-X7533U E1: KDC-W6534U E2: KDC-W6534UY
(E : Europe K : North America M : Other Areas W : Without Europe)

△ Indicates safety critical components.

PARTS LIST

CD PLAYER UNIT (X32-5830-00)

Ref. No.	Add	New	Parts No.	Description	Destination
R69			RK73GB2A682J	CHIP R 6.8K J 1/10W	
R70			RK73GB2A102J	CHIP R 1.0K J 1/10W	
R71-73			RK73GB2A101J	CHIP R 100 J 1/10W	
R109			RK73GH2A822D	CHIP R 8.2K D 1/10W	
R110			RK73GH2A392D	CHIP R 3.9K D 1/10W	
R112			RK73GH2A682D	CHIP R 6.8K D 1/10W	
R115			RK73GH2A822D	CHIP R 8.2K D 1/10W	
R116			RK73GH2A682D	CHIP R 6.8K D 1/10W	
R118,119			RK73GH2A100D	CHIP R 10 D 1/10W	
R121			RK73GH2A392D	CHIP R 3.9K D 1/10W	
R130			RK73GB2A102J	CHIP R 1.0K J 1/10W	
R132			RK73GB2A102J	CHIP R 1.0K J 1/10W	
R133			RK73GB2A681J	CHIP R 680 J 1/10W	
R138			RK73GB2A101J	CHIP R 100 J 1/10W	
R142			RK73FB2B4R7J	CHIP R 4.7 J 1/8W	
R144			RK73GB2A223J	CHIP R 22K J 1/10W	
R148			RK73GB2A103J	CHIP R 10K J 1/10W	
R151			RK73GB2A102J	CHIP R 1.0K J 1/10W	
R152			RK73GB2A221J	CHIP R 220 J 1/10W	
R153			RK73GB2A100J	CHIP R 10 J 1/10W	
R154,155			RK73GB2A330J	CHIP R 33 J 1/10W	
R300,301			RK73GB2A680J	CHIP R 68 J 1/10W	
R302			RK73GB2A101J	CHIP R 100 J 1/10W	
R304			RK73GB2A101J	CHIP R 100 J 1/10W	
R306,307			RK73GB2A270J	CHIP R 27 J 1/10W	
R308-310			RK73GB2A153J	CHIP R 15K J 1/10W	
R311-316			RK73GB2A100J	CHIP R 10 J 1/10W	
R320-323			RK73GB2A101J	CHIP R 100 J 1/10W	
R336			RK73GB2A101J	CHIP R 100 J 1/10W	
R337			RK73GB2A153J	CHIP R 15K J 1/10W	
R339			RK73GB2A682J	CHIP R 6.8K J 1/10W	
R345			RK73GB2A103J	CHIP R 10K J 1/10W	
R346			RK73GB2A102J	CHIP R 1.0K J 1/10W	
R348			RK73GB2A223J	CHIP R 22K J 1/10W	
R351			RK73GB2A103J	CHIP R 10K J 1/10W	
R353			RK73GB2A473J	CHIP R 47K J 1/10W	
R358,359			RK73GB2A473J	CHIP R 47K J 1/10W	
R361			RK73GB2A223J	CHIP R 22K J 1/10W	
R363			RK73GB2A223J	CHIP R 22K J 1/10W	
R366			RK73GB2A101J	CHIP R 100 J 1/10W	
R368			RK73GB2A472J	CHIP R 4.7K J 1/10W	
R369			RK73GB2A102J	CHIP R 1.0K J 1/10W	
R370			RK73GB2A101J	CHIP R 100 J 1/10W	
R371			RK73GB2A2R2J	CHIP R 2.2 J 1/10W	
R372,373			RK73FB2B2R2J	CHIP R 2.2 J 1/8W	
R374			RK73GB2A473J	CHIP R 47K J 1/10W	
S1,2			S68-0863-05	PUSH SWITCH	
S3			S68-0862-05	PUSH SWITCH	
D2			DA204U	DIODE	
D3			DAN202U	DIODE	
D9			DA204U	DIODE	
IC1	*		M30620FCPPG	MICROCONTROLLER IC	
IC2			UPD63712GC	MOS-IC	

Ref. No.	Add	New	Parts No.	Description	Destination
IC4			BA5824FP	ANALOGUE IC	
IC5		*	BD33KA5WFP-E2	ANALOGUE IC	
IC13		*	NJM2100V-ZB	ANALOGUE IC	
IC14			TAR5S50-F	ANALOGUE IC	
IC15			CS7410-IQZ	MOS-IC	
IC16		*	IC42S164007TIG	DRAM IC	
IC17		*	29LV800CBT19V1	ROM IC	
IC18			PCM1754DB	MOS-IC	
IC19		*	R1114N331B-TR	ANALOGUE IC	
IC20		*	S-1132B18U5T1G	ANALOGUE IC	
IC21		*	BD33KA5WFP-E2	ANALOGUE IC	
IC25		*	TDUHC1240F0C00	MOS-IC	
IC26		*	TC74LCX00FT-F	MOS-IC	
IC28		*	TC7WH125FK-F	MOS-IC	
Q3			UMD9N	TRANSISTOR	
Q6			UMD12N	TRANSISTOR	
Q7			DTC124EE	DIGITAL TRANSISTOR	
Q8			2SB0970	TRANSISTOR	
Q9			DTC114YE	DIGITAL TRANSISTOR	
Q10			DTC114YUA	DIGITAL TRANSISTOR	
Q17			DTA143XUA	DIGITAL TRANSISTOR	
ELECTRIC UNIT (X34-415x-xx)					
D302			B30-1710-05	LED (RED)	
C1			C90-6746-05	ELECTRO 3300UF 16WV	
C2			CC73GCH1H070D	CHIP C 7.0PF D	
C3			C90-5692-05	ELECTRO 220UF 16WV	
C5			CD04AS1V100M	ELECTRO 10UF 35WV	
C6			CD04AS0J101M	ELECTRO 100UF 6.3WV	
C7			CK73FB1C105K	CHIP C 1.0UF K	
C8			CD04AT1A221M	ELECTRO 220UF 10WV	
C9			CD04BA1C101M	ELECTRO 100UF 16WV	
C10			CK73EB1E105K	CHIP C 1.0UF K	
C11			CD04AS1HR47M	ELECTRO 0.47UF 50WV	
C12			CD04BF1V470M	ELECTRO 47UF 35WV	
C13			CK73GB1H104K	CHIP C 0.10UF K	
C14			CD04AS1C101M	ELECTRO 100UF 16WV	KM1
C15			CD04AS1C220M	ELECTRO 22UF 16WV	KM1
C16			CD04AS1C470M	ELECTRO 47UF 16WV	KM1
C18			CD04BF1E101M	ELECTRO 100UF 25WV	
C20			CD04BK1A221M	ELECTRO 220UF 10WV	
C24			CK73GB1A334K	CHIP C 0.33UF K	
C25			CD04AS1C220M	ELECTRO 22UF 16WV	
C40,41			CC73GCH1H070D	CHIP C 7.0PF D	
C45			CK73GB1H104K	CHIP C 0.10UF K	
C50			CK73GB1H104K	CHIP C 0.10UF K	
C53			CK73GB1H104K	CHIP C 0.10UF K	
C101			CD04AS1H3R3M	ELECTRO 3.3UF 50WV	
C102			CK73GB1A105K	CHIP C 1.0UF K	
C103			CK73GB1H104K	CHIP C 0.10UF K	
C104			CK73GB1H103K	CHIP C 0.010UF K	
C105			CK73GB1H223K	CHIP C 0.022UF K	
C106			CK73GB1A105K	CHIP C 1.0UF K	
C109-111			CK73GB1H103K	CHIP C 0.010UF K	

K: KDC-X590 K1: KDC-MP632U M1: KDC-X7533U E1: KDC-W6534U E2: KDC-W6534UY
(E : Europe K : North America M : Other Areas W : Without Europe)

△ Indicates safety critical components.

PARTS LIST

ELECTRIC UNIT (X34-415x-xx)

Ref. No.	A d d	N e w	Parts No.	Description	Desti- nation	Ref. No.	A d d	N e w	Parts No.	Description	Desti- nation
C201			CD04AS0J470M	ELECTRO 47UF 6.3WV		CN4			E41-2446-05	PIN ASSY	
C202			CK73GB1H103K	CHIP C 0.010UF K		CN5			E41-0944-05	PIN ASSY	KE1E2
C203,204			CC73GCH1H220J	CHIP C 22PF J		J1			E58-0991-05	RECTANGULAR RECEPTACLE	
C205			CK73GB1H104K	CHIP C 0.10UF K		J2			E56-0855-05	CYLINDRICAL RECEPTACLE	
C206,207			CK73GB1H103K	CHIP C 0.010UF K		J3			E63-0896-05	PIN JACK	K1E1E2
C208			CK73GB1H102K	CHIP C 1000PF K		J3			E63-0897-05	PIN JACK	KM1
C209			CK73GB1H103K	CHIP C 0.010UF K		J4			E58-0992-05	RECTANGULAR RECEPTACLE	
C210,211			CK73GB1H471K	CHIP C 470PF K		W1	2D		E30-6218-15	CORD WITH PLUG	
C302			CK73GB1H103K	CHIP C 0.010UF K		L1		*	L33-2319-05	CHOKO COIL ASSY	
C304,305			CK73GB1H103K	CHIP C 0.010UF K		L3		*	L33-2335-05	CHOKO COIL	
C306			CD04AS1V100M	ELECTRO 10UF 35WV		L201			L41-4795-33	SMALL FIXED INDUCTOR (4.7UH)	
C307			CK73GB1H103K	CHIP C 0.010UF K		L203			L92-0339-05	CHIP FERRITE	
C308			CD04AS1V100M	ELECTRO 10UF 35WV		L301			L33-2260-05	CHOKO COIL	
C309			CK73GB1H103K	CHIP C 0.010UF K		L302-304			L41-4795-33	SMALL FIXED INDUCTOR (4.7UH)	
C310			CD04BF1V470M	ELECTRO 47UF 35WV		L306			L41-4795-33	SMALL FIXED INDUCTOR (4.7UH)	E1E2
C311			CK73GB1H103K	CHIP C 0.010UF K		L307		*	L92-0616-05	CHIP FERRITE	
C312			CD04BK1C101M	ELECTRO 100UF 16WV		X1			L77-2880-05	CRYSTAL RESONATOR (32.768KHZ)	
C313			CD04AS1V100M	ELECTRO 10UF 35WV		X2			L78-0872-05	RESONATOR (12MHZ)	
C323			CK73GB1H103K	CHIP C 0.010UF K		X3			L77-2002-05	CRYSTAL RESONATOR (4.332MHZ)	E1E2
C343			CK73GB1H104K	CHIP C 0.10UF K	K1E1E2						
C347			CK73GB1H102K	CHIP C 1000PF K		G	2D		N80-3010-48	PAN HEAD TAPTITE SCREW	
C350			CC73GCH1H331J	CHIP C 330PF J	E1E2	J	2D		N83-3005-48	PAN HEAD TAPTITE SCREW	
C351			CK73GB1H103K	CHIP C 0.010UF K	E1E2	K	2D		N83-3020-48	PAN HEAD TAPTITE SCREW	
C352			CK73GB0J225K	CHIP C 2.2UF K	E1E2	M	2D		N82-2608-48	BINDING HEAD TAPTITE SCREW	
C353			CD04AS1V100M	ELECTRO 10UF 35WV	E1E2						
C354,355			CC73GCH1H120J	CHIP C 12PF J	E1E2	CP201,202			RK74GB1J101J	CHIP-COM 100 J 1/16W	
C401			CD04AS1C470M	ELECTRO 47UF 16WV		CP203			RK74GA1J471J	CHIP-COM 470 J 1/16W	
C402,403			CD04AS1H010M	ELECTRO 1UF 50WV		CP206			RK74GB1J222J	CHIP-COM 2.2K J 1/16W	
C404			CK73GB1A105K	CHIP C 1.0UF K		CP207			RK74GB1J102J	CHIP-COM 1.0K J 1/16W	
C406,407			CK73FB1A335K	CHIP C 3.3UF K		CP209			RK74GB1J101J	CHIP-COM 100 J 1/16W	
C408,409			CK73FB1C105K	CHIP C 1.0UF K	KK1M1	R1			RK73FB2B153J	CHIP R 15K J 1/8W	
C411			CD04AS1H2R2M	ELECTRO 2.2UF 50WV		R3			RK73GB2A223J	CHIP R 22K J 1/10W	
C412			CD04AS1V100M	ELECTRO 10UF 35WV	KM1	R4			RK73GB2A472J	CHIP R 4.7K J 1/10W	
C413,414			CK73FB1E474K	CHIP C 0.47UF K		R5			RK73FB2B221J	CHIP R 220 J 1/8W	
C415,416			CD04AS1H2R2M	ELECTRO 2.2UF 50WV		R7			RK73GH2A243D	CHIP R 24K D 1/10W	
C417-420			CD04AS1V100M	ELECTRO 10UF 35WV	K1E1E2	R8			RK73GH2A432D	CHIP R 4.3K D 1/10W	
C417-422			CD04AS1V100M	ELECTRO 10UF 35WV	KM1	R9			RK73FB2B152J	CHIP R 1.5K J 1/8W	
C423,424			CC73GCH1H070D	CHIP C 7.0PF D		R10			RK73FB2B222J	CHIP R 2.2K J 1/8W	
C426,427			CK73FB1E474K	CHIP C 0.47UF K	K1E1E2	R11			RK73GH2A273D	CHIP R 27K D 1/10W	
C428			CD04AS0J470M	ELECTRO 47UF 6.3WV	K1E1E2	R12			RK73GH2A332D	CHIP R 3.3K D 1/10W	
C429			CK73GB1H103K	CHIP C 0.010UF K	K1E1E2	R13			RK73GB2A102J	CHIP R 1.0K J 1/10W	
C431			CD04AS1V100M	ELECTRO 10UF 35WV		R17,18			RK73GB2A223J	CHIP R 22K J 1/10W	
C440			CC73GCH1H070D	CHIP C 7.0PF D		R20			RK73GB2A473J	CHIP R 47K J 1/10W	
C501			CK73FB1C105K	CHIP C 1.0UF K		R21			RK73GB2A103J	CHIP R 10K J 1/10W	
C503-506	*		C90-6779-05	ELECTRO 0.47UF 16WV		R22			RK73PB2H220J	CHIP R 22 J 1/2W	KM1
C507			CK73FB1C105K	CHIP C 1.0UF K		R23			RK73GB2A102J	CHIP R 1.0K J 1/10W	KM1
C510,511			CK73FB1E474K	CHIP C 0.47UF K		R24			RK73GB2A513J	CHIP R 51K J 1/10W	KM1
C512			CD04AS0J470M	ELECTRO 47UF 6.3WV		R25,26			RK73GB2A102J	CHIP R 1.0K J 1/10W	KM1
C513			CK73GB1H103K	CHIP C 0.010UF K		R27			RK73GB2A221J	CHIP R 220 J 1/10W	KM1
C529,530			C90-6711-05	ELECTRO 1UF 50WV		R28,29			RK73GB2A2R2J	CHIP R 2.2 J 1/10W	KM1
C802			CK73GB1H102K	CHIP C 1000PF K		R30			RK73GB2A332J	CHIP R 3.3K J 1/10W	KM1
C999			CD04BM1E330M	ELECTRO 33UF 25WV		R41			RK73GB2A201J	CHIP R 200 J 1/10W	
CN1		*	E41-2629-05	FLAT CABLE CONNECTOR		R42			RK73GB2A121J	CHIP R 120 J 1/10W	
CN2			E41-0944-05	PIN ASSY		R43,44		*	R92-5110-05	CHIP R 2.7 J 3/4W	
						R45			RK73GB2A473J	CHIP R 47K J 1/10W	

K: KDC-X590 K1: KDC-MP632U M1: KDC-X7533U E1: KDC-W6534U E2: KDC-W6534UY
(E : Europe K : North America M : Other Areas W : Without Europe)

△ Indicates safety critical components.

PARTS LIST

ELECTRIC UNIT (X34-415x-xx)

Ref. No.	Add	New	Parts No.	Description	Destination	Ref. No.	Add	New	Parts No.	Description	Destination
R46-51		*	R92-5110-05	CHIP R 2.7 J 3/4W		R240			RK73GB2A101J	CHIP R 100 J 1/10W	
R52			RK73GH2A472D	CHIP R 4.7K D 1/10W		R241			RK73GB2A222J	CHIP R 2.2K J 1/10W	K1
R53			RK73GH2A332D	CHIP R 3.3K D 1/10W		R241,242			RK73GB2A222J	CHIP R 2.2K J 1/10W	KM1E1
R55		*	R92-5110-05	CHIP R 2.7 J 3/4W		R241,242			RK73GB2A222J	CHIP R 2.2K J 1/10W	E2
R56			RK73GB2A153J	CHIP R 15K J 1/10W		R243			RK73GB2A473J	CHIP R 47K J 1/10W	K1
R57		*	R92-5110-05	CHIP R 2.7 J 3/4W		R244			RK73GB2A473J	CHIP R 47K J 1/10W	KM1
R101			RK73EB2E102J	CHIP R 1.0K J 1/4W	KM1E1	R244,245			RK73GB2A473J	CHIP R 47K J 1/10W	E1E2
R101			RK73EB2E102J	CHIP R 1.0K J 1/4W	E2	R246			RK73GB2A473J	CHIP R 47K J 1/10W	KK1
R102,103			RK73EB2E103J	CHIP R 10K J 1/4W		R246,247			RK73GB2A473J	CHIP R 47K J 1/10W	M1
R104			RK73EB2E472J	CHIP R 4.7K J 1/4W		R248-250			RK73GB2A473J	CHIP R 47K J 1/10W	KK1E1
R105			RK73PB2H221J	CHIP R 220 J 1/2W	KK1M1	R248-250			RK73GB2A473J	CHIP R 47K J 1/10W	E2
R106			RK73GB2A223J	CHIP R 22K J 1/10W	KK1M1	R249,250			RK73GB2A473J	CHIP R 47K J 1/10W	M1
R107			RK73FB2B472J	CHIP R 4.7K J 1/8W		R254			RK73GB2A473J	CHIP R 47K J 1/10W	
R108			R92-5024-05	CHIP R 1K J 1/2W		R257,258			RK73GB2A222J	CHIP R 2.2K J 1/10W	
R109			RK73GB2A223J	CHIP R 22K J 1/10W		R259,260			RK73GB2A104J	CHIP R 100K J 1/10W	
R110			R92-5024-05	CHIP R 1K J 1/2W		R261			RK73GB2A333J	CHIP R 33K J 1/10W	
R111			RK73FB2B561J	CHIP R 560 J 1/8W	KM1E1	R262,263			RK73GB2A473J	CHIP R 47K J 1/10W	E2
R111			RK73FB2B561J	CHIP R 560 J 1/8W	E2	R270			RK73GB2A473J	CHIP R 47K J 1/10W	
R112			RK73GB2A223J	CHIP R 22K J 1/10W		R301			RK73EB2E102J	CHIP R 1.0K J 1/4W	
R113			RK73GB2A473J	CHIP R 47K J 1/10W		R302,303			RK73EB2E101J	CHIP R 100 J 1/4W	
R114			RK73GB2A104J	CHIP R 100K J 1/10W		R304			RK73EB2E102J	CHIP R 1.0K J 1/4W	
R115			RK73FB2B683J	CHIP R 68K J 1/8W		R305-309			RK73EB2E101J	CHIP R 100 J 1/4W	
R116			RK73GB2A393J	CHIP R 39K J 1/10W		R310			RK73EB2E102J	CHIP R 1.0K J 1/4W	
R117			RK73FB2B203J	CHIP R 20K J 1/8W		R311			RK73GB2A222J	CHIP R 2.2K J 1/10W	
R118			RK73GB2A104J	CHIP R 100K J 1/10W		R312			RK73GB2A473J	CHIP R 47K J 1/10W	
R122,123			RK73GB2A103J	CHIP R 10K J 1/10W		R313			RK73GB2A472J	CHIP R 4.7K J 1/10W	
R124			RK73GB2A104J	CHIP R 100K J 1/10W		R316			RK73GB2A104J	CHIP R 100K J 1/10W	
R125			RK73GB2A223J	CHIP R 22K J 1/10W		R317			RK73GB2A471J	CHIP R 470 J 1/10W	
R126			RD14DB2H332J-T	SMALL-RD 3.3K J 1/2W		R318			RK73GB2A472J	CHIP R 4.7K J 1/10W	
R127			RK73EB2E333J	CHIP R 33K J 1/4W		R320			RK73FB2B102J	CHIP R 1.0K J 1/8W	
R128			RK73GB2A103J	CHIP R 10K J 1/10W		R321			RK73GB2A223J	CHIP R 22K J 1/10W	
R130			RK73GB2A102J	CHIP R 1.0K J 1/10W		R322			RK73GB2A471J	CHIP R 470 J 1/10W	
R131			RK73GB2A473J	CHIP R 47K J 1/10W		R323			RK73GB2A472J	CHIP R 4.7K J 1/10W	
R132			RK73PB2H221J	CHIP R 220 J 1/2W	KK1M1	R324			RK73GB2A471J	CHIP R 470 J 1/10W	
R201			RK73GB2A222J	CHIP R 2.2K J 1/10W		R325			RK73GB2A472J	CHIP R 4.7K J 1/10W	
R202			RK73GB2A225J	CHIP R 2.2M J 1/10W		R327			RK73GB2A681J	CHIP R 680 J 1/10W	
R203			RK73GB2A104J	CHIP R 100K J 1/10W		R329-331			RK73GB2A222J	CHIP R 2.2K J 1/10W	E1E2
R204			RK73GB2A102J	CHIP R 1.0K J 1/10W		R332			RK73GB2A241J	CHIP R 240 J 1/10W	
R206			RK73GB2A102J	CHIP R 1.0K J 1/10W		R333			RK73GB2A102J	CHIP R 1.0K J 1/10W	E1E2
R207			RK73GB2A103J	CHIP R 10K J 1/10W		R336			RK73GB2A104J	CHIP R 100K J 1/10W	
R208			RK73GB2A102J	CHIP R 1.0K J 1/10W		R337,338			RK73GB2A102J	CHIP R 1.0K J 1/10W	
R210			RK73GB2A473J	CHIP R 47K J 1/10W		R339			RK73GB2A474J	CHIP R 470K J 1/10W	
R211			RK73GB2A102J	CHIP R 1.0K J 1/10W		R342			RK73GB2A471J	CHIP R 470 J 1/10W	
R212			RK73GB2A473J	CHIP R 47K J 1/10W		R401			RK73GB2A103J	CHIP R 10K J 1/10W	
R215			RK73GB2A104J	CHIP R 100K J 1/10W		R402,403			RK73GB2A331J	CHIP R 330 J 1/10W	
R216			RK73GB2A102J	CHIP R 1.0K J 1/10W		R404,405			RK73GB2A223J	CHIP R 22K J 1/10W	
R220			RK73GB2A223J	CHIP R 22K J 1/10W	E1E2	R406,407			RK73GB2A331J	CHIP R 330 J 1/10W	
R221			RK73GB2A104J	CHIP R 100K J 1/10W		R408,409			RK73GB2A223J	CHIP R 22K J 1/10W	
R224			RK73GB2A473J	CHIP R 47K J 1/10W		R410,411			RK73GB2A331J	CHIP R 330 J 1/10W	KM1
R227,228			RK73GB2A472J	CHIP R 4.7K J 1/10W		R412,413			RK73GB2A223J	CHIP R 22K J 1/10W	KM1
R229,230			RK73GB2A473J	CHIP R 47K J 1/10W		R414-419			RK73FB2B181J	CHIP R 180 J 1/8W	KM1
R233			RK73GB2A101J	CHIP R 100 J 1/10W		R414,415			RK73FB2B181J	CHIP R 180 J 1/8W	K1E1E2
R234,235			RK73GB2A392J	CHIP R 3.9K J 1/10W		R420,421			RK73FB2B181J	CHIP R 180 J 1/8W	K1E1E2
R236,237			RK73GB2A473J	CHIP R 47K J 1/10W		R422			RK73EB2E4R7J	CHIP R 4.7 J 1/4W	K1E1E2
R239			RK73GB2A222J	CHIP R 2.2K J 1/10W		R423,424			RK73EB2E100J	CHIP R 10 J 1/4W	K1E1E2

K: KDC-X590 K1: KDC-MP632U M1: KDC-X7533U E1: KDC-W6534U E2: KDC-W6534UY
(E : Europe K : North America M : Other Areas W : Without Europe)

△ Indicates safety critical components.

PARTS LIST

ELECTRIC UNIT (X34-415x-xx)

Ref. No.	A d d	N e w	Parts No.	Description	Desti- nation	Ref. No.	A d d	N e w	Parts No.	Description	Desti- nation
R425			RK73GB2A102J	CHIP R 1.0K J 1/10W	K1E1E2	D107			02DZ4.7F-Y	ZENER DIODE	
R426			RK73GB2A222J	CHIP R 2.2K J 1/10W	KM1	D108,109			02DZ6.8F-Y	ZENER DIODE	
R427			RK73GB2A472J	CHIP R 4.7K J 1/10W	KM1	D111			02DZ6.2F-Y	ZENER DIODE	
R428			RK73GB2A102J	CHIP R 1.0K J 1/10W	KM1	D301			IMSA-6802-E	SURGE ABSORBER	
R429			RK73GB2A473J	CHIP R 47K J 1/10W	KM1	D303			02DZ9.1F-Z	ZENER DIODE	
R430			RK73GB2A101J	CHIP R 100 J 1/10W		D304			IMSA-6802-E	SURGE ABSORBER	
R431			RK73GB2A100J	CHIP R 10 J 1/10W		D401-403			BAW56W	DIODE	
R432			RK73EB2E2R2J	CHIP R 2.2 J 1/4W		D404			UDZS3.3B	ZENER DIODE	
R433,434			RK73GB2A101J	CHIP R 100 J 1/10W		D405,406			02DZ6.8F-Y	ZENER DIODE	K1E1E2
R435			RK73GB2A102J	CHIP R 1.0K J 1/10W		D407			02DZ5.6F-Y	ZENER DIODE	KM1
R442			RK73GB2A121J	CHIP R 120 J 1/10W		D408			DA204K	DIODE	
R501			RK73GB2A102J	CHIP R 1.0K J 1/10W		D411			BAW56W	DIODE	KM1
R503			RK73GB2A752J	CHIP R 7.5K J 1/10W		D412,413			UDZS5.6B	ZENER DIODE	KK1M1
R505			RK73GB2A432J	CHIP R 4.3K J 1/10W		D414			02DZ6.2F-Y	ZENER DIODE	K1E1E2
R506			RK73GB2A223J	CHIP R 22K J 1/10W		D500-502			BAW56W	DIODE	E1E2
R507			RK73GB2A221J	CHIP R 220 J 1/10W		D501,502			BAW56W	DIODE	KK1M1
R508			RK73EB2E472J	CHIP R 4.7K J 1/4W		D503,504			1SR154-400	DIODE	
R509			RK73EB2E101J	CHIP R 100 J 1/4W		D505,506			1SR139-400T64	DIODE	
R510			RK73EB2E472J	CHIP R 4.7K J 1/4W		D507-510			1SR154-400	DIODE	
R511-515			RK73EB2E101J	CHIP R 100 J 1/4W		D511-515			02DZ6.2F-Y	ZENER DIODE	K1M1
R516,517			RK73EB2E100J	CHIP R 10 J 1/4W		D511-523			02DZ6.2F-Y	ZENER DIODE	KE1E2
R518			RK73EB2E4R7J	CHIP R 4.7 J 1/4W		D518-520			02DZ6.2F-Y	ZENER DIODE	K1M1
R519			RK73GB2A102J	CHIP R 1.0K J 1/10W		D523			02DZ6.2F-Y	ZENER DIODE	K1M1
R520			RK73EB2E102J	CHIP R 1.0K J 1/4W	KK1E1	IC1	*		30624MWPA86GP	MICROCONTROLLER IC	
R520			RK73EB2E102J	CHIP R 1.0K J 1/4W	E2	IC2			E-TDA7415C	ANALOGUE IC	
R521-523			RK73EB2E471J	CHIP R 470 J 1/4W	E1E2	IC3			M5237ML-CF0J	ANALOGUE IC	
R524			RK73GB2A100J	CHIP R 10 J 1/10W		IC4			E-TDA7560A	ANALOGUE IC	
R530			RK73GB2A100J	CHIP R 10 J 1/10W		IC5			BA00CCWT-V5	ANALOGUE IC	
R531			RK73GB2A2R2J	CHIP R 2.2 J 1/10W		IC6			SN74HC02APWR	MOS-IC	
W2,3			R92-1252-05	CHIP R 0 OHM J 1/16W	E1E2	IC7			S-80836CNNB-J	MOS-IC	
W3			R92-1252-05	CHIP R 0 OHM J 1/16W	KK1M1	IC8	*		MIC2026-1YM	MOS-IC	
W14			R92-2053-05	CHIP R 0 OHM J 1/8W	KM1	IC9			E-TDA7479AD	ANALOGUE IC	E1E2
W15			R92-2053-05	CHIP R 0 OHM J 1/8W	K1E1E2	IC10			BR24L04FV-W	ROM IC	
W16			R92-1252-05	CHIP R 0 OHM J 1/16W		IC11			TA75S558F-F	ANALOGUE IC	KM1
W17-20			R92-2053-05	CHIP R 0 OHM J 1/8W		IC12	*		SI-8050RF3NF	ANALOGUE IC	
W21			R92-1252-05	CHIP R 0 OHM J 1/16W		IC13			BA00CC0WFP	ANALOGUE IC	
W931			R92-1252-05	CHIP R 0 OHM J 1/16W		Q1			2SB1565	TRANSISTOR	
W997,998			R92-1252-05	CHIP R 0 OHM J 1/16W		Q2			KTC4075P (Y,GR)	TRANSISTOR	
S3			S74-0822-05	MICRO SWITCH		Q3,4			KTA2014P (Y,GR)	TRANSISTOR	
S4			S70-0931-05	TACT SWITCH		Q5			2SB1565	TRANSISTOR	
D1			S2V60*A	DIODE		Q6			DTA124EUA	DIGITAL TRANSISTOR	
D2			RB160L-40	DIODE		Q7			2SB1565	TRANSISTOR	
D3			02DZ5.6F-Y	ZENER DIODE		Q8			KTC4075P (Y,GR)	TRANSISTOR	
D4			02DZ8.2F-Y	ZENER DIODE		Q9-11			DTC124EUA	DIGITAL TRANSISTOR	
D5		*	02DZ20F-Y	ZENER DIODE		Q12			2SA1488NF	TRANSISTOR	
D6		*	PTZ4.7B	ZENER DIODE		Q13			KTA2014P (Y,GR)	TRANSISTOR	
D8			02DZ12F-X	ZENER DIODE	KM1	Q14,15			KTC4075P(Y,GR)	TRANSISTOR	KM1
D9			1SR154-400	DIODE	KM1	Q16			2SB1443	TRANSISTOR	KM1
D10		*	RB081L-20	DIODE		Q17			DTC144EUA	DIGITAL TRANSISTOR	
D52,53			02DZ6.8F-Y	ZENER DIODE		Q21			KTC4075P (Y,GR)	TRANSISTOR	
D101			10EDA20	DIODE		Q101			2SB1188 (Q,R)	TRANSISTOR	KK1M1
D102-105			1SR154-400	DIODE		Q102			DTC114YUA	DIGITAL TRANSISTOR	KK1M1
D106			02DZ5.6F-Y	ZENER DIODE	KM1E1	Q103			2SB1188 (Q,R)	TRANSISTOR	
D106			02DZ5.6F-Y	ZENER DIODE	E2	Q104			KTA2014P (Y,GR)	TRANSISTOR	
						Q105			DTA114EUA	DIGITAL TRANSISTOR	

K: KDC-X590 K1: KDC-MP632U M1: KDC-X7533U E1: KDC-W6534U E2: KDC-W6534UY
(E : Europe K : North America M : Other Areas W : Without Europe)

△ Indicates safety critical components.

PARTS LIST

ELECTRIC UNIT (X34-415x-xx)

Ref. No.	A d d	N e w	Parts No.	Description	Desti- nation	
Q106			DTC114YUA	DIGITAL TRANSISTOR	KM1E1 E2	
Q107			DTA123JK	DIGITAL TRANSISTOR		
Q107			DTA123JK	DIGITAL TRANSISTOR		
Q108			DTC144EUA	DIGITAL TRANSISTOR		
Q109			2SC4155A (Q,R,S)	TRANSISTOR		
Q111,112			2SC4155A (Q,R,S)	TRANSISTOR		
Q113			KTA2014P (Y,GR)	TRANSISTOR		
Q116			DTA124EUA	DIGITAL TRANSISTOR		
Q300			2SB1689	TRANSISTOR		
Q301			DTC124EUA	DIGITAL TRANSISTOR		
Q302			2SB1565	TRANSISTOR	K1E1E2 KM1 K1E1E2	
Q303			KTC4075P (Y,GR)	TRANSISTOR		
Q304			DTC114YUA	DIGITAL TRANSISTOR		
Q305			2SA1577	TRANSISTOR		
Q306			DTC144EUA	DIGITAL TRANSISTOR		
Q400-403			DTC143TUA	DIGITAL TRANSISTOR		
Q400-407			DTC143TUA	DIGITAL TRANSISTOR		
Q406,407			DTC143TUA	DIGITAL TRANSISTOR		
Q408			DTA124EUA	DIGITAL TRANSISTOR	K1E1E2 KM1 K1E1E2	
TH1			PRF18BE471QS2	POSITIVE RESISTOR		
A1	2D	*	X86-4000-11	FRONT-END UNIT	KK1M1	
A1	2D	*	X86-4002-70	FRONT-END UNIT	E1E2	
MECHANISM ASSY (X92-5440-00: K/K1/M1, X92-5440-04: E1/E2)						
2	1B		A10-4827-32	CHASSIS	E1E2 KK1M1	
5	2B		D10-4576-93	ARM ASSY		
8	2A		D10-4787-63	LEVER ASSY		
8	2A	*	D10-4901-13	LEVER ASSY		
10	2A		D10-4581-13	ARM		
11	2A		D10-4582-13	ARM		
12	3A		D10-4583-03	ARM		
13	3A		D10-4584-03	ARM		
14	3B		D10-4585-03	ARM		
15	2A		D10-4586-13	SLIDER		
16	3B		D10-4587-52	SLIDER		
17	2B		D10-4588-13	SLIDER		
18	2B		D10-4595-04	ARM		
19	2B		D10-4596-24	ARM		
22	2A		D13-2151-04	GEAR		
23	2B		D13-2152-04	GEAR		
24	3B		D13-2153-04	GEAR		
25	3B		D13-2154-04	GEAR		
26	3B		D13-2155-04	WORM		
27	2B		D13-2156-14	GEAR		
28	3B		D13-2157-04	GEAR		
29	2B		D13-2158-04	GEAR		
30	2B		D13-2168-04	GEAR		
31	3B		D13-2171-04	GEAR		
32	1B		D13-2172-13	RACK (GEAR)		
33	2A		D14-0759-04	ROLLER		
35	2B		D21-2382-04	SHAFT		
36	1A		D23-0954-04	RETAINER		
37	1B		D39-0246-05	DAMPER		KK1M1
37	1B		D39-0260-05	DAMPER		E1E2

Ref. No.	A d d	N e w	Parts No.	Description	Desti- nation
38	2B		G01-3072-04	EXTENSION SPRING	E1E2
39	2A		G01-3073-04	TORSION COIL SPRING	
40	2A		G01-3074-04	EXTENSION SPRING	
41	1B		G01-3075-24	EXTENSION SPRING	
42	2A		G01-3076-04	EXTENSION SPRING	
43	1B		G01-3077-14	EXTENSION SPRING	
44	2B		G02-1399-04	FLAT SPRING	
45	2B		G02-1408-04	FLAT SPRING	
46	3B		F09-1804-04	SHEET	
47	3A	*	F09-2824-14	SHEET	
51	1A		J21-9676-32	MOUNTING HARDWARE	E1E2
52	3B		J21-9677-22	MOUNTING HARDWARE	
53	1B		J21-9678-13	MOUNTING HARDWARE	
55	1A		J90-1001-11	GUIDE	
56	1B		J90-1023-03	GUIDE	
DFPC1	3A		J86-0027-05	FPC (LEAD FREE)	
A	2B		N09-4460-15	TAPTITE SCREW (PT2X8)	
B	1B		N09-4472-25	MACHINE SCREW (M1.7X8.0)	
C	2B		N09-6004-15	MACHINE SCREW (M1.7X2.5)	
E	2B		N09-6007-15	MACHINE SCREW (PAN M2X2)	
F	1A		N09-6051-15	TAPTITE SCREW (BIND PT2X5)	
G	2A		N19-2163-04	FLAT WASHER (1.6X6X0.25)	E1E2
H	1B		N39-2020-46	PAN HEAD MACHINE SCREW (M2X2)	
J	1B		N09-6108-15	TAPTITE SCREW (M2X3.5)	
K	3B		N09-6155-15	SEMS (TAPTITE SCREW) (PT2X6)	
DM1	3B		T42-1066-14	DC MOTOR (SPINDLE)	
DM2	2B		T42-1067-14	DC MOTOR (LOADING)	
DPU1	2B		X93-2010-01	OPTICAL PICKUP ASSY (LEAD FREE)	

K: KDC-X590 K1: KDC-MP632U M1: KDC-X7533U E1: KDC-W6534U E2: KDC-W6534UY
(E : Europe K : North America M : Other Areas W : Without Europe)

△ Indicates safety critical components.

SPECIFICATIONS

FM tuner section

Frequency range	
KDC-W6534U/X7533U	87.5MHz~108.0MHz (50kHz space)
KDC-MP632U/X590/X7533U	87.9MHz~107.9MHz (200kHz space)
Usable sensitivity	
KDC-MP632U/X590/X7533U (S/N=30dB)	9.3dBf (0.8 μ V/75 Ω)
KDC-W6534U (S/N=26dB)	0.7 μ V/75 Ω
Quieting Sensitivity	
KDC-MP632U/X590/X7533U (S/N=50dB)	15.2dBf (1.6 μ V/75 Ω)
KDC-W6534U (S/N=46dB)	1.6 μ V/75 Ω
Frequency response (\pm 3.0dB)	30Hz~15kHz
Signal to Noise ratio (MONO)	
KDC-MP632U/X590/X7533U	70dB
KDC-W6534U	65dB
Selectivity (\pm 400kHz)	\geq 80dB
Stereo separation (1kHz)	
KDC-MP632U/X590/X7533U	40dB
KDC-W6534U	35dB

AM tuner section (KDC-MP632U/X590/X7533U)

Frequency range	
KDC-X7533U	531kHz~1611kHz (9kHz space)
KDC-MP632U/X590/X7533U	530kHz~1700kHz (10kHz space)
Usable sensitivity (S/N=20dB)	28dB μ (25 μ V)

MW tuner section (KDC-W6534U)

Frequency range (9kHz space)	531kHz~1611kHz
Usable sensitivity (S/N=20dB)	25 μ V

LW tuner section (KDC-W6534U)

Frequency range	153kHz~281kHz
Usable sensitivity (S/N=20dB)	45 μ V

CD player section

Laser diode	GaAlAs
Digital filter (D/A)	8 Times Over Sampling
D/A Converter	1Bit
Spindle speed	1000~400rpm (CLV 2times)
Wow & Flutter	Below Measurable Limit
Frequency response (\pm 1dB)	10Hz~20kHz

DANGER:

Please do not look the laser beam directly during repair or operation check.

Total harmonic distortion (1kHz)

KDC-W6534U/X590/X7533U	0.008%
KDC-MP632U	0.01%
Signal to Noise ratio (1kHz)	
KDC-W6534U/X590/X7533U	110dB
KDC-MP632U	105dB
Dynamic range	93dB
MP3 decode	Compliant with MPEG-1/2 Audio Layer-3
WMA decode	Compliant with Windows Media Audio
AAC decode	AAC-LC ".m4a" files

Audio section

Maximum output power	50W x 4
Full Bandwidth Power (at less than 1% THD)	
KDC-MP632U/X590/X7533U	22W x 4
Output power (DIN 45324, +B=14.4V)	
KDC-W6534U	30W x 4
Speaker impedance	4~8 Ω
Tone action	
Bass	100Hz \pm 8dB
Middle	1kHz \pm 8dB
Treble	10kHz \pm 8dB
Preout level/Load (during disc play)	
KDC-MP632U/W6534U	2500mV/10k Ω
KDC-X590/X7533U	4000mV/10k Ω
Preout impedance	\leq 600 Ω

USB Interface

USB Standard	USB1.1/2.0
File System	FAT16/32
Maximum Supply current	500mA
MP3 decode	Compliant with MPEG-1/2 Audio Layer-3
WMA decode	Compliant with Windows Media Audio
AAC decode	AAC-LC ".m4a" files

Auxiliary input (KDC-MP632U/W6534U)

Frequency response (\pm 1dB)	20Hz~20kHz
Input Maximum Voltage	1200mV
Input impedance	100k Ω

General

Operating voltage (11~16V allowable)	14.4V
Current consumption	10A
Installation Size (W x H x D)	182 x 53 x 155mm
	7-3/16 x 2-1/16 x 6-1/8inch
Weight	3.1lbs (1.40kg)

KENWOOD follows a policy of continuous advancements in development.

For this reason specifications may be changed without notice.

